

LAUFEN

Bathroom Culture since 1892  www.laufen.com



laufenpro



For quite some time good design has no longer been the sole privilege of those who have powerful financial means. It is thanks to current industrial production methods and designers like Peter Wirz of «Process Design», who subscribe to optimal feasibility for their creations, that ceramic lines like LAUFEN pro are developing. This development is welcomed by designers as well as by customers.

Gutes Design ist heute längst nicht mehr nur einer zahlungskräftigen Käuferschicht vorbehalten. Dank industrieller Produktionsweise und Designern wie Peter Wirz von Process Design, die bei ihren Kreationen auch stets die optimale Machbarkeit vor Augen haben, können Keramikserien wie LAUFEN pro entstehen. Das findet nicht nur der Designer gut, sondern vor allem auch der Kunde.

Aujourd'hui, le beau design n'est plus réservé à une caste de clients aux moyens financiers illimités. Grâce à la production industrielle et à des designers tels que Peter Wirz de Process Design qui, dans leur créativité, ont toujours à l'esprit une faisabilité optimale, des séries céramique comme celles proposées par LAUFEN sont désormais chose possible. Le designer y trouve certes son compte, mais aussi et surtout le client.

Oggi il bel design non è più riservato solo ad una fascia alta di mercato. Grazie ai metodi di produzione industriale ed a designer come Peter Wirz della Process Design, che tengono sempre in considerazione la fattibilità di ogni creazione, è nata la serie di sanitari LAUFEN pro. Perfetta non solo per i designer ma anche e soprattutto per i clienti.

| | | |
|------------------------------|----|------------------------------------|
| | 04 | Why our clients rely on LAUFEN pro |
| SANITARY WARE | 06 | LAUFEN pro Overview |
| | 08 | LAUFEN pro S |
| | 18 | LAUFEN pro B |
| | 22 | LAUFEN pro A |
| | 26 | LAUFEN pro WCs |
| | 32 | LAUFEN pro rimless WC |
| SPECIAL APPLICATIONS | 34 | Hotel solutions |
| | 36 | Public spaces |
| | 40 | LAUFEN pro liberty |
| BATHROOM FURNITURE | 44 | LAUFEN pro furniture |
| BATHTUBS | 48 | LAUFEN pro bathtubs |
| FAUCETS | 50 | cityplus |
| | 52 | citypro |
| FEATURES AND BENEFITS | 54 | Sanitary ware |
| | 58 | Furniture |
| | 59 | Bathtubs |
| | 60 | Faucets |

| | | |
|------------------------------|-----|------------------------|
| TECHNICAL INFORMATION | 62 | LAUFEN pro S |
| | 72 | LAUFEN pro B |
| | 76 | LAUFEN pro A |
| | 81 | LAUFEN pro WCs |
| | 81 | LAUFEN pro rimless WC |
| | 90 | Caprino plus |
| | 91 | LAUFEN pro liberty |
| | 92 | LAUFEN pro bathtubs |
| | 97 | cityplus/cityplus zero |
| | 100 | citpro |

It is possible that not all products, sizes or colours are available in every country. The price list of your LAUFEN/ROCA subsidiary is the most accurate reference point for product availability. Delivery periods may also differ.

Unter Umständen sind nicht alle Produkte, Größen oder Farben in jedem Land verfügbar. Bitte nutzen Sie die Preisliste der jeweiligen LAUFEN/ROCA Niederlassung als Referenz für das verfügbare Produktsortiment. Auch die jeweiligen Lieferzeiten können von Land zu Land abweichen.

Il se peut que les produits ne soient pas tous disponibles dans chaque pays dans toutes les dimensions et coloris. La liste de prix de votre filiale LAUFEN/ROCA est la référence la plus sûre en ce qui concerne la disponibilité des produits. Les délais de livraisons peuvent également varier d'un pays à l'autre.

È possibile che non tutti i prodotti, le misure e i colori siano ugualmente disponibili in ogni Paese. Si prega di utilizzare il listino prezzi della vostra filiale LAUFEN/ROCA come riferimento per la gamma di prodotti disponibili. Anche i tempi di consegna possono variare da un Paese all'altro.

Why our clients rely on LAUFEN pro



Why the building contractor relies on LAUFEN pro

As one of the world leaders in the manufacturing of sanitary ceramics, LAUFEN is intimately familiar with the building trade and their customers. We also realise that the bathroom has become an increasingly important criterion for the success of private and public projects. LAUFEN responds to this Renaissance of bathroom culture with a multiplicity of bathroom programmes extending into the luxury class. With its continually enhanced, successful LAUFEN pro range, LAUFEN demonstrates that good design and good quality do not necessarily mean high installation costs, because contemporary industrial design implemented intelligently can be attractive both to the eye and the budget.

Weshalb der Unternehmer mit LAUFEN pro rechnet

Als einer der weltweit führenden Hersteller von Sanitärkeramik kennt LAUFEN die Besonderheiten des Baugewerbes und seiner Kunden. Und weiss deshalb auch, dass das Badezimmer sich immer mehr zu einem wichtigen Kriterium für den Erfolg von privaten und öffentlichen Projekten entwickelt hat. LAUFEN begegnet dieser Renaissance der Badekultur mit einer Vielzahl von Badezimmerprogrammen, die bis in die Luxusklasse reichen. Mit dem bewährten und stetig weiterentwickelten LAUFEN pro tritt LAUFEN den Beweis an, dass gutes Design und gute Qualität nicht mit hohen Anschaffungskosten gleichgesetzt werden müssen. Denn zeitgemäßes Industriedesign kann, wenn intelligent produziert, sowohl für das Auge als auch für das Budget attraktiv sein.

Voici pourquoi l'entrepreneur se fie à LAUFEN pro

Faisant partie des leaders mondiaux de la céramique sanitaire, LAUFEN connaît les particularités du secteur de la construction et de ses clients. Et sait aussi que la salle de bain est un critère de plus en plus décisif pour la réussite de projets privés et publics. LAUFEN va au-devant de cette renaissance de l'art du bain avec un grand nombre de programmes de salles de bains qui culminent dans les agencements de luxe. Avec la solution éprouvée et en constante évolution LAUFEN pro, la preuve est donnée, si besoin était, que le bon design et l'excellente qualité ne sont pas forcément synonymes de coûts d'acquisition élevés. Car le design industriel actuel, s'il est intelligemment produit, peut être à la fois attrayant pour l'œil et pour le budget.

Ecco perché l'impresa edile conta su LAUFEN pro

Essendo uno tra i principali produttori di sanitari in ceramica al mondo, LAUFEN conosce perfettamente le esigenze delle imprese edili e dei loro clienti. Sa quindi anche che il bagno ha acquistato un valore sempre più importante per il successo di progetti pubblici e privati. LAUFEN risponde a questa rinascita della cultura del bagno con una ampia molteplicità di serie, anche di lusso. Con la serie LAUFEN pro, LAUFEN dimostra che bel design e buona qualità non significano necessariamente prezzi alti. Il design industriale moderno, se abbinato ad una produzione intelligente, può essere attraente sia a livello estetico che di prezzo.



Why the architect and the interior designer plans with LAUFEN pro

The bathroom used to be regarded merely as a functional room to which little importance was attached. With the growing emphasis on wellness, the desire for relaxation and care became progressively stronger. Today architects accept these wishes for more bath culture and require bathroom programmes that can meet various expectations. They prefer flexible systems that allow the optimal use of space. Design concepts that can be integrated continuously.

Weshalb der Architekt und der Interior Designer mit LAUFEN pro plant

Früher war das Badezimmer lediglich ein reiner Funktionsraum und wurde deshalb gestalterisch vernachlässigt. Heute ist das Bad ein Wellnessraum; hier entspannen und pflegen sich die Menschen. Architekten greifen den Wunsch nach mehr Badekultur auf und verlangen nach Badezimmerprogrammen, die diesen Ansprüchen gerecht werden. Sie schätzen flexible Systeme, die eine optimale Raumausnutzung ermöglichen und Designkonzepte, die sich durchgängig integrieren lassen.

Voici pourquoi l'architecte et le designer planifient avec LAUFEN pro

Dans le passé, la salle de bain n'était qu'une simple cellule humide et donc sans grande importance. Mais avec la vague croissante de bien-être, le souhait de disposer d'un véritable lieu de détente et de soins n'a cessé de se propager. Aujourd'hui, les architectes exaucent ce désir et cette demande en programmes de salles de bains répondant aux attentes les plus exigeantes. Ils apprécient les systèmes souples, gages d'une exploitation optimale de l'espace. Des concepts de design qui s'intègrent sans faille.

Ecco perché l'architetto e il designer utilizzano LAUFEN pro per i loro progetti

Una volta, il bagno era solo una stanza in cui lavarsi e non aveva quindi molta importanza. Con l'evolversi del concetto di benessere, si è intensificato anche il desiderio di un luogo di relax e cura del corpo. Oggi gli architetti fanno proprie queste richieste e scelgono prodotti in grado di soddisfarle. Apprezzano i sistemi flessibili che permettono uno sfruttamento ottimale dello spazio. Idee di design perfettamente integrabili.



Why sanitary plumbers are happy to use LAUFEN pro products

To prevent wasting the time or nerves of sanitary engineers, all LAUFEN pro products are extremely easy to install, comply with the specifications of the different countries and are always readily available. In this way building operations are expedited.

Weshalb der Sanitärinstallateur LAUFEN pro gerne in die Hand nimmt

Damit der Sanitärinstallateur weder Zeit noch Nerven verliert, sind alle Produkte von LAUFEN pro äusserst montagefreundlich, erfüllen die länderspezifischen Vorgaben und sind immer schnell verfügbar. So kommt der Bau im Handumdrehen voran.

Voici pourquoi l'installateur sanitaire prend volontiers en main LAUFEN pro

Parce que l'installateur sanitaire n'a pas de temps à perdre, tous les produits de LAUFEN pro sont d'un montage extrêmement aisé, satisfont aux normes spécifiques de chaque pays et leur disponibilité est toujours très rapide. Ainsi, il n'y a aucun retard de construction à déplorer.

Ecco perché l'installatore ama lavorare con LAUFEN pro

Per non far perdere né tempo né pazienza all'installatore, tutti gli articoli della serie LAUFEN pro sono estremamente facili da montare e rispettano le normative nazionali. Così i lavori finiscono prima.

laufenpro S

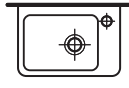

36 x 25 cm

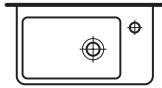

48 x 28 cm

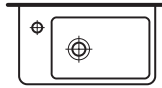

48 x 28 cm

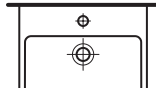

45 x 34 cm

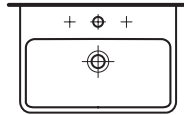

55 x 38 cm

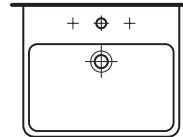

55 x 46.5 cm

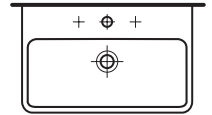

60 x 38 cm

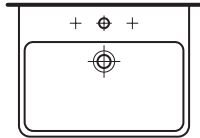

60 x 46.5 cm

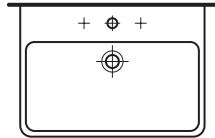

65 x 46.5 cm

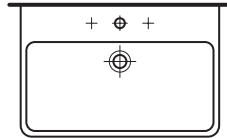

70 x 46.5 cm

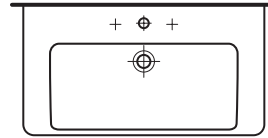

85 x 46 cm

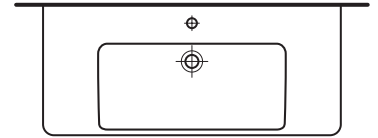

105 x 46 cm

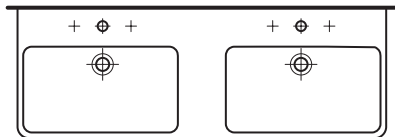

130 x 46 cm

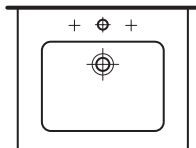

60 x 50 cm

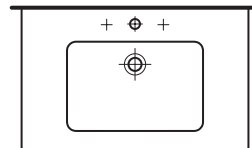

80 x 50 cm

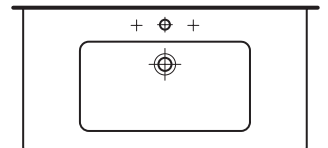

100 x 50 cm

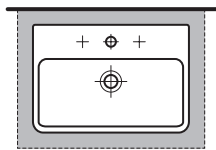

55 x 38 cm

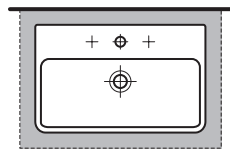

60 x 38 cm

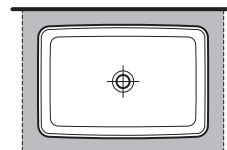

60 x 40 cm

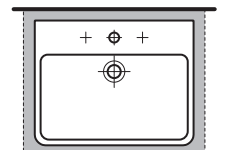

56 x 44 cm

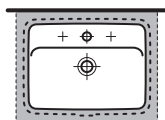

49 x 36 cm

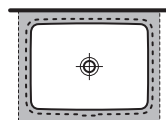

49 x 36 cm

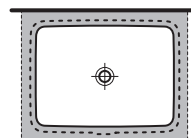

55 x 43 cm

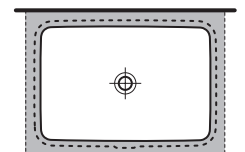

60 x 45 cm

laufen pro B



50 x 25 cm

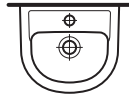

35 x 31 cm

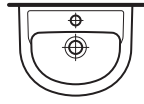

40 x 32 cm

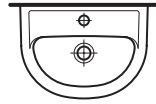

45 x 33 cm



50 x 36 cm

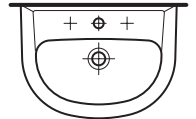

55 x 40 cm

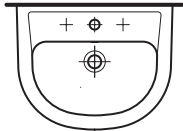

55 x 44 cm

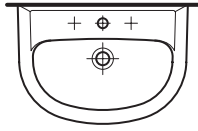

60 x 42 cm

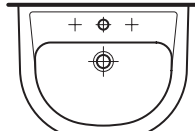

60 x 48 cm

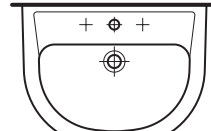

65 x 50 cm



31 x 31 cm



35 x 35 cm

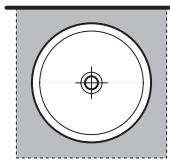

42 x 42 cm

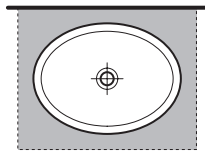

52 x 39 cm

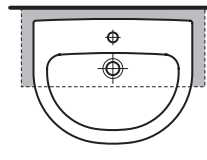

56 x 44 cm

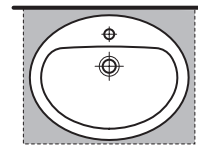

56 x 44 cm

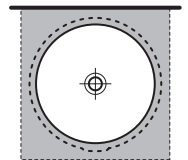

46.5 x 47 cm

laufen pro A

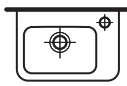

36 x 25 cm

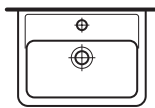

45 x 34 cm

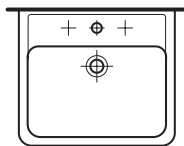

55 x 48 cm

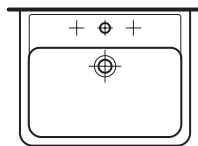

60 x 48 cm

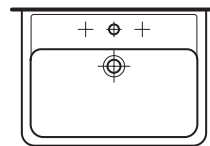

65 x 48 cm

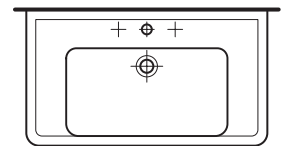

85 x 48 cm

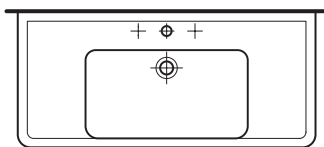

105 x 48 cm

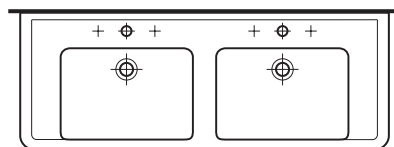

130 x 48 cm

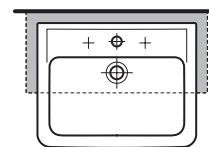

56 x 44 cm

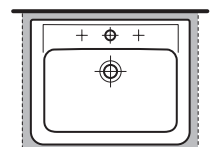

56 x 44 cm

proliberty

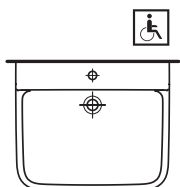

65 x 55 cm

laufenpro S



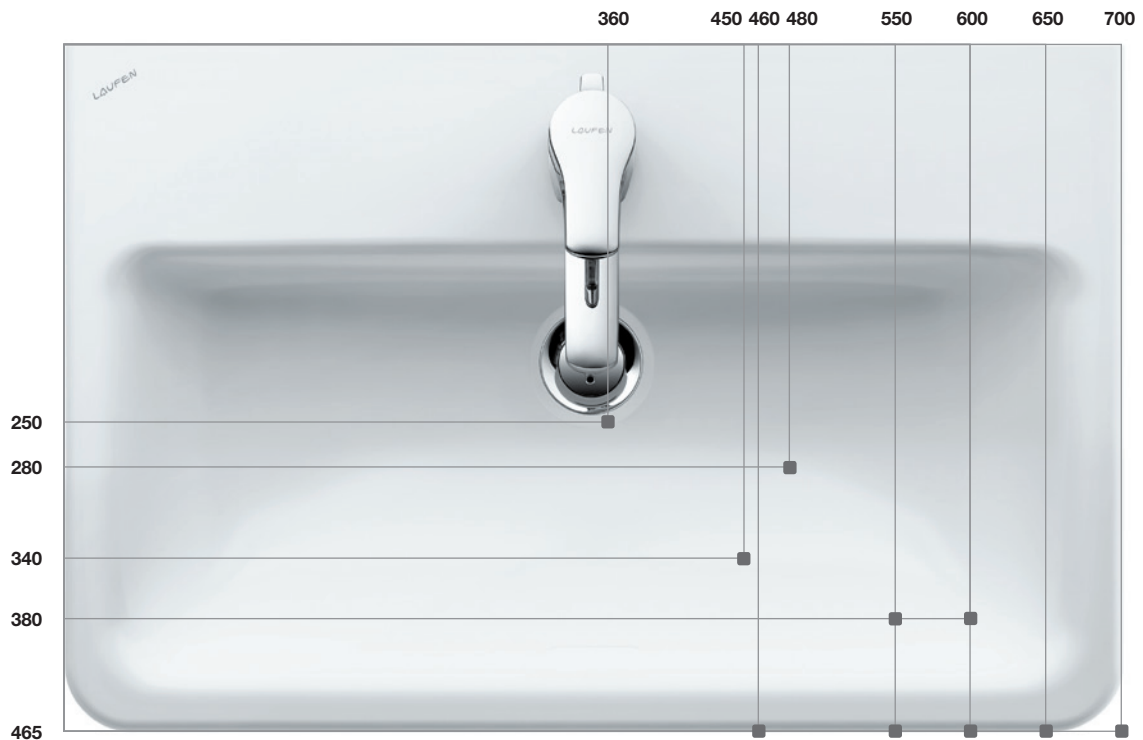

The Swiss designer Peter Wirz is responsible for LAUFEN pro S. With heaps of sensitivity, he brought about a systematic, production-optimised evolution of the pro concept: Thanks to its slim silhouette and clearly-defined radii, the washbasin has a light and elegant appearance. The deep bowl means that it's also functionally appealing. The aesthetics of LAUFEN pro S therefore definitely take the range in the direction of LAUFEN's premium design lines – while remaining affordable by all.

Mit viel Fingerspitzengefühl verfolgte Designer Peter Wirz bei LAUFEN pro S eine konsequente, produktionsoptimierte Evolution des pro-Gedankens: Dank ihrer schlanken Silhouette und den klar definierten Radien wirken die Waschtische leicht und elegant, das tiefe Becken sorgt für viel Funktionalität. Damit rückt die Ästhetik von LAUFEN pro S zweifellos in Richtung der Premium-Designlinien von LAUFEN – und bleibt doch für jedermann erschwinglich.

LAUFEN pro S est une création du designer suisse Peter Wirz. Avec beaucoup de doigté, il était en quête d'une évolution, conséquente et optimisée pour la production, du projet pro: Grâce à sa silhouette élancée et aux rayons clairement définis, les lavabos ont une apparence légère et élégante, la vasque profonde garantit une grande fonctionnalité. L'esthétique de LAUFEN pro S peut, sans le moindre doute, rivaliser avec les autres lignes au design hors pair signé LAUFEN – tout en restant abordable pour tous.

LAUFEN pro S è stata progettata dal designer svizzero Peter Wirz, che ha perseguito e ottimizzato con grande sensibilità l'evoluzione coerente del concetto che sta alla base della serie pro. Grazie alla sua linea slanciata e ai bordi arrotondati molto definiti, i lavabi hanno un aspetto leggero ed elegante, mentre la profondità del bacino garantisce un'elevata funzionalità. L'estetica di LAUFEN pro S si avvicina indubbiamente a quella delle linee di design premium di LAUFEN, pur rimanendo alla portata di tutti.





The new LAUFEN pro S WC is a geometric wall-hung WC which comes with a matching bidet. It fits in perfectly with the redesign of the LAUFEN pro S washbasins. Thanks to the concealed LAUFEN EasyFit mounting system (PCT pat. pend.), the ceramics have a flawless appearance and are easy to clean.

Das neue LAUFEN pro S WC ist ein geometrisches Wand-WC samt passendem Bidet, das perfekt mit dem Redesign der LAUFEN pro S Waschtische harmonisiert. Dank des zum Patent angemeldeten, versteckten Montagesystems LAUFEN EasyFit präsentiert sich die Keramik makellos und reinigungsfreundlich.

Le nouveau WC LAUFEN pro S est un WC mural géométrique, fourni avec un bidet assorti, qui se marie parfaitement avec les lavabos LAUFEN pro S remaniés. Grâce au système de montage invisible LAUFEN EasyFit (PCT pat. pend.), la céramique reste impeccable et se nettoie facilement.

Il nuovo vaso LAUFEN pro S è un vaso sospeso di linea geometrica e coordinato al bidet, che si armonizza perfettamente con il re-design dei lavabi LAUFEN pro S. Grazie al sistema di montaggio nascosto LAUFEN EasyFit (PCT pat. pend.), i sanitari si presentano nella loro perfezione e sono più facili da pulire.



Please find information about **LAUFEN EasyFit fixation** on page 55.

Informationen zur **LAUFEN EasyFit fixation** finden Sie auf Seite 55.

Pour informations relatives à **LAUFEN EasyFit fixation** voir sur page 55.

Per informazioni su **LAUFEN EasyFit fixation** consultare pagina 55.



If space is scarce, good ideas are required. Laufen pro S compact solutions give you the opportunity to devise a comprehensive design concept, even in the most restricted spaces. Our washbasins and WCs have a short projection which saves valuable space.

Wo wenig Raum vorhanden ist, sind gute Ideen gefragt. Mit den kompakten Problemlösern von LAUFEN pro kann ein durchgängiges Designkonzept selbst bei engsten Raumverhältnissen realisiert werden. Waschtische und WCs haben eine geringere Ausladung und sparen so wertvollen Platz ein.

Là où l'espace est rare, il faut avoir de bonnes idées. Les solutions compactes aux problèmes de LAUFEN pro permettent de réaliser un concept de design homogène, même dans les espaces les plus exigus. Les lavabos et WC présentent un faible allongement et permettent ainsi d'économiser de l'espace précieux.

Laddove lo spazio è poco, ci vogliono buone idee. Con le soluzioni compatte LAUFEN pro è possibile realizzare un progetto di design completo anche in spazi molto ridotti. I lavabi e i vasi presentano una profondità ridotta e consentono di risparmiare spazio prezioso.



The LAUFEN pro S range contains practical furniture with high-quality details such as integrated handles and gently closing drawers with no siphon cut-out. Available in glossy white, matt white, wenge, graphite and 38 special colours.

Zu LAUFEN pro S gehören praktische Möbel mit wertigen Details wie integrierte Griffleisten oder sanft schliessende Schubladen ohne Siphonausschnitt. Erhältlich in Weiss glänzend, Weiss matt, Wenge und Graphit sowie 38 weiteren Sonderfarben.

LAUFEN pro S se compose de meubles pratiques avec des détails valorisants comme les poignées intégrées ou les tiroirs à fermeture en douceur sans découpe pour le siphon. Existe en blanc brillant, blanc mat, wengé et graphite et 38 autres coloris spéciaux.

La serie LAUFEN pro S é costituita da mobili pratici dai dettagli di pregio, come le maniglie a barra integrate o i cassetti che si chiudono delicatamente, senza taglio per il sifone. Sono disponibili nei colori Bianco brillante, Bianco opaco, Wengé e Grafite, ed inoltre in altri 38 colori speciali.





Slim, light and bold – LAUFEN pro S is the new member of the successful LAUFEN pro series. Thanks to the delicate redesign, the elegant pro S is compatible with all pro variants.

Schlanker, leichter, klarer – LAUFEN pro S ist das neue Familienmitglied der erfolgreichen LAUFEN pro Serie. Ihr behutsames Redesign macht das elegante pro S kompatibel zu allen pro-Varianten.

Encore plus élancé, plus léger et plus clair – LAUFEN pro S est le nouveau membre de la famille de la série LAUFEN pro, couronnée de succès. Grâce au remaniement, avec précaution, de son design, l'élégant pro S est compatible avec toutes les variantes pro.

Più snello, più leggero, più pulito: LAUFEN pro S è il nuovo componente della fortunata serie LAUFEN pro. Il suo avveduto re-design rende l'elegante pro S compatibile con tutte le versioni della serie pro.









The elegant and subtle LAUFEN pro S furniture-mounted washbasins with deep, highly functional bowls and generously sized shelves are new to the range. These are only available together with the matching furniture in the range.

Une nouveauté de l'assortiment: les élégants lavabos pour meubles LAUFEN pro S aux formes élancées avec une profonde vasque fonctionnelle et de grands espaces de rangement. Ces lavabos sont exclusivement disponibles en liaison avec les meubles assortis de la série.

Neu im Sortiment sind die eleganten, feinen LAUFEN pro S Möbelwaschtische mit einem funktionalen, tiefen Becken und grosszügigen Ablagen. Diese sind nur im Paket mit den dazu passenden Möbeln der Serie erhältlich.

La novità dell'assortimento è data dagli eleganti e raffinati lavabi consolle LAUFEN pro S, dal bacino profondo e funzionale e dalle ampie mensole, disponibili solamente in pacchetto insieme ai mobili abbinabili della serie.



laufen pro B



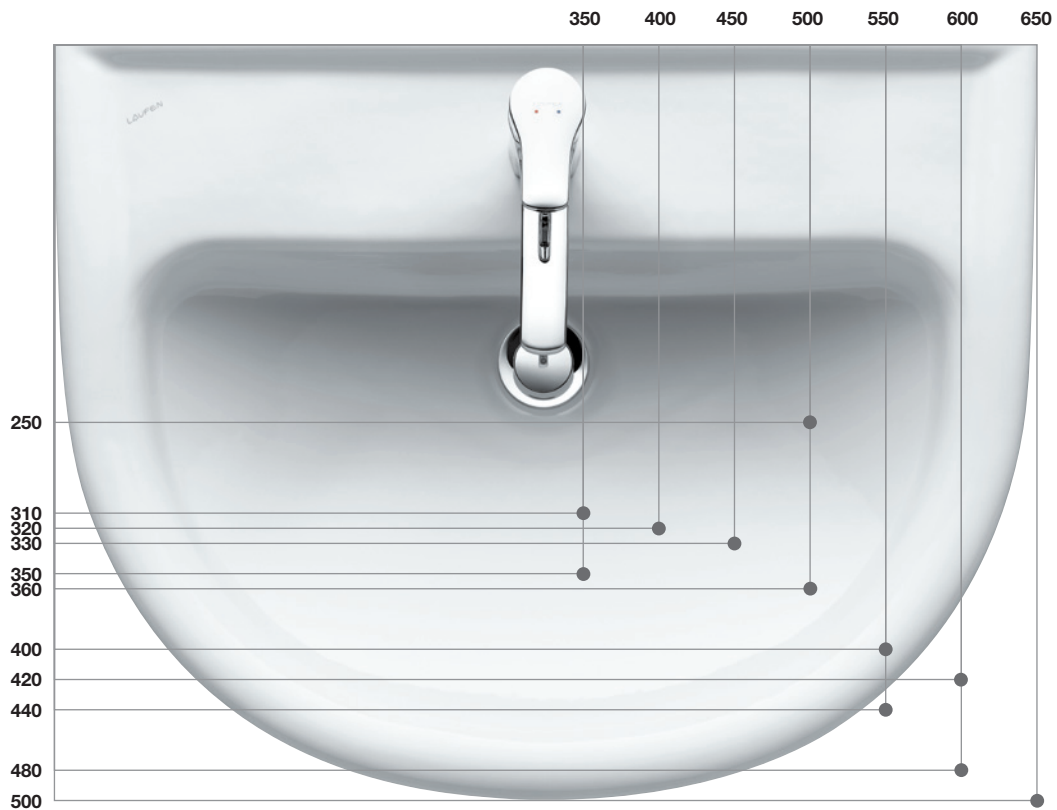

With LAUFEN pro B, LAUFEN has set a standard in the bathroom. The design has a broad appeal and relies upon sweeping curves which have proven their worth in the bathroom thanks to their body-friendly characteristics. The continuous edge around the washbasin provides high-quality functionality since it protects against overflows. With more than ten different sizes and special washbasin solutions – e.g. washbasin bowls, drop-in washbasins, and built-in washbasins – LAUFEN pro B meets all requirements placed upon a bathroom.

Mit LAUFEN pro B hat LAUFEN einen Standard im Bad gesetzt. Das mehrheitsfähige Design setzt auf runde, geschwungene Linien, die sich aufgrund ihrer körperfreundlichen Eigenschaften im Bad bewährt haben. Für hohe Funktionalität sorgt der umlaufende Rand, der vor überlaufendem Wasser schützt. Mit mehr als zehn verschiedenen Grössen und speziellen Waschtisch-Lösungen – zum Beispiel Aufsatzwaschtische sowie unterbau- oder einbaufähige Waschtische – zeigt sich LAUFEN pro B allen Anforderungen im Bad gewachsen.

Avec LAUFEN pro B, LAUFEN a fixé une norme dans la salle de bain. Le design qui remporte une large adhésion mise sur des lignes arrondies et ondulées qui ont fait leur preuve dans la salle de bain en raison de leurs caractéristiques adaptées au corps. Le bord circulaire, qui empêche l'eau de déborder, assure une fonctionnalité exceptionnelle. Avec plus de dix tailles différentes et des solutions de lavabo spéciales, par exemple des lavabos à encastrer et à poser, LAUFEN pro B répond parfaitement à toutes les exigences posées à la salle de bain.

Con la serie LAUFEN pro B LAUFEN ha stabilito un nuovo standard per la stanza da bagno. Il design è in grado di incontrare il favore della maggioranza del pubblico e punta su linee arrotondate e curve che si sono ormai affermate nel bagno grazie alle loro ergonomicità. L'alta funzionalità è garantita dal bordo periferico e impedisce la fuoriuscita di acqua. Con più di dieci misure diverse e soluzioni speciali per lavabo, come ad esempio lavabi da appoggio e lavabi sottopiano o da incasso, la serie LAUFEN pro B soddisfa tutti i requisiti per il bagno.



Oval washbasin bowl on case washtop with drawer element.

Ovaler Aufsatz-Waschtisch auf case Waschtischplatte mit Schubladenelement.

Lavabo à poser ovale sur plan de toilette case avec tiroirs.

Bacinella ovale su piano d'appoggio case con cassetti sottolavabo.



Round washbasin bowl on case washtop 600 mm.

Runder Aufsatz-Waschtisch auf 600 mm case Waschtischplatte.

Lavabo à poser rond sur plan de toilette case 600 mm.

Bacinella rotonda su piano d'appoggio case da 600 mm.



laufen pro A



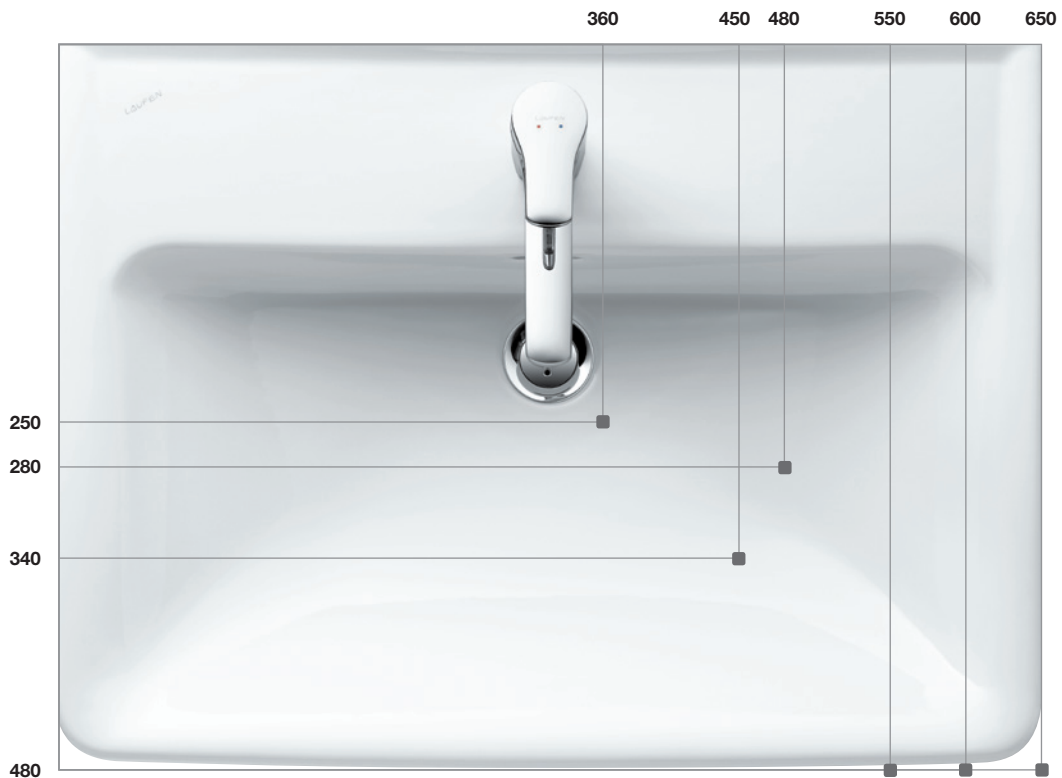

LAUFEN pro A is characterised by a reduced, right-angled design vocabulary which has established itself in bathrooms with higher design aspirations. An important design and functional characteristic of the washbasins is the continuous edge, which allows water that overflows to run back into the basin. Thanks to its wide portfolio – with more than 10 different sizes and special solutions such as washbasin bowls, drop-in washbasins, and built-in washbasins – LAUFEN pro A is the range of choice for the building industry and private homes.

LAUFEN pro A zeichnet sich durch eine reduzierte, rechtwinklige Formensprache aus, die sich in Badezimmern mit gehobenem Designanspruch etabliert hat. Wichtigstes Design- und Funktionsmerkmal der Waschtische ist der umlaufende Rand, der übergetretenes Wasser zurück ins Becken fließen lässt. Dank einer breiten Auswahl, die mehr als 10 verschiedene Größen sowie spezielle Lösungen wie Aufsatzwaschtische, unterbau- oder einbaufähige Waschtische umfasst, ist LAUFEN pro A erste Wahl im Objektbau aber auch in Privathaushalten.

LAUFEN pro A se caractérise par un langage formel réduit, à angles droits qui s'est établi dans les salles de bain aux exigences de design élevées. Une caractéristique esthétique et fonctionnelle importante des lavabos est le bord circulaire qui permet à l'eau qui déborde de s'écouler à nouveau dans la baignoire. Grâce à un choix élevé qui comprend plus de 10 tailles différentes ainsi que des solutions spéciales notamment les lavabos à encastrer et à poser, LAUFEN pro A représente le premier choix dans la construction industrielle mais aussi dans les ménages.

La serie LAUFEN pro A è caratterizzata da una forma rettangolare, ridotta, che si è affermata in bagni con standard di progettazione di alto livello. La caratteristica funzionale e di design principale dei lavabi è il bordo periferico, che fa ritornare nel bacino l'acqua che straripa. Grazie ad una vasta scelta che comprende più di 10 misure differenti, nonché soluzioni speciali come lavabi da appoggio, sottopiano o da incasso, la serie LAUFEN pro A rappresenta la prima scelta sia nell'edilizia che in ambito privato.





Please find information about **Laufen Clean Coat** on page 54.

Informationen zur **Laufen Clean Coat** finden Sie auf Seite 54.

Pour informations relatives à **Laufen Clean Coat** voir sur page 54.

Per informazioni su **Laufen Clean Coat** consultare pagina 54.

laufenpro WCs and Bidets

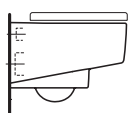
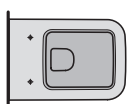

53 x 43 cm

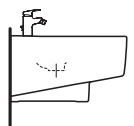

53 x 43 cm

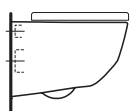
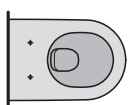

53 x 43 cm

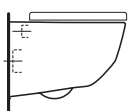

53 x 43 cm
rimless

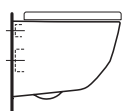

49 x 43 cm
rimless

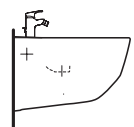

53 x 43 cm

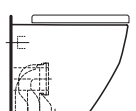

53 x 43 cm

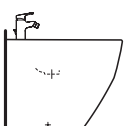

53 x 43 cm

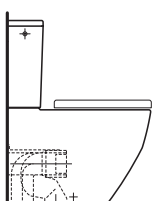

65 x 43 cm

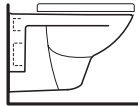
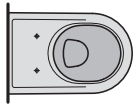

56 x 40 cm

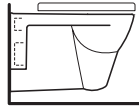

56 x 40 cm

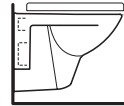

56 x 40 cm

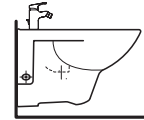

56 x 40 cm

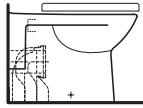

56 x 40 cm

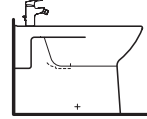

56 x 40 cm

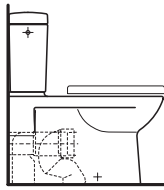

70 x 40 cm

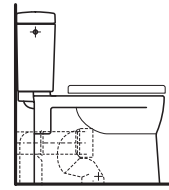

67 x 40 cm

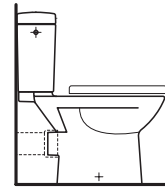

67 x 40 cm

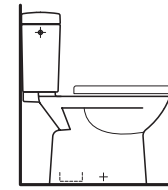

67 x 40 cm

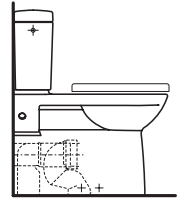

70 x 46 cm

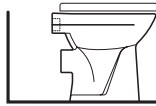

47 x 40 cm

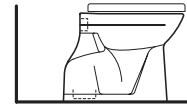

47 x 40 cm

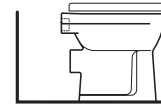

47 x 40 cm



55 x 40 cm

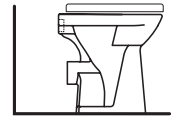

47 x 45 cm

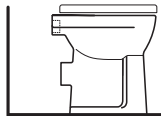

47 x 45 cm

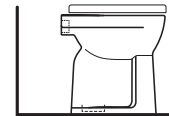

47 x 45 cm

proliberty

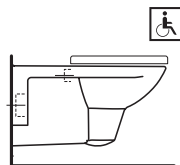
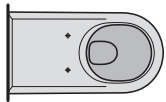

70 x 45 cm

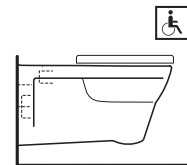

70 x 45 cm

laufen^{pro} WCs and Bidets



The WCs and bidets in the LAUFEN pro range are suitable for all applications – most of which are equipped with an economical 4.5/3-litre flushing system.

Zu LAUFEN pro gehören WCs und Bidets für jeden Anwendungsfall – die meisten mit sparsamer 4,5/3 l-Spülung.

LAUFEN pro propose des WC et bidets adaptés à tous les besoins, la plupart équipés d'un système d'économie d'eau de 4,5/3 l.

LAUFEN pro include vasi e bidet per ogni tipo di installazione; quasi tutti sono dotati di sistema di sciacquo a risparmio idrico da 4,5/3 litri.

Please find information about **LAUFEN EasyFit fixation** on page 55.

Informationen zur **LAUFEN EasyFit fixation** finden Sie auf Seite 55.

Pour informations relatives à **LAUFEN EasyFit fixation** voir sur page 55.

Per informazioni su **LAUFEN EasyFit fixation** consultare pagina 55.



Shapely floorstanding cistern for back-to-wall floorstanding WCs.

Formschöner Universal Stand-Spülkasten für wandbündige Stand-WCs.

Beau réservoir au sol pour WC au sol dos au mur.

Cassetta di risciacquo a pavimento di bella forma per vaso a pavimento a filo muro.



Back-to-wall WC combination with LAUFEN pro seat and cover and vario outlet.

Wandbündige WC-Kombination mit LAUFEN pro Sitz und Deckel und Vario-Abgang.

Installation de WC dos au mur avec siège et abattant de WC LAUFEN pro set sortie Vario.

Vaso monoblocco a filo muro con nuovo sedile e coperchio LAUFEN pro e scarico Vario.



Compact WC rimless with 490 mm projection.

Compact WC rimless mit 490 mm Ausladung.

Compact WC rimless avec saillie de 490 mm.

Vaso Compact rimless con sporgenza di 490 mm.



Back-to-wall and floorstanding WC and bidet.

Wandbündiges und bodenstehendes WC und Bidet.

WC et bidet au sol et dos au mur.

Vaso e bidet a pavimento a filo muro.

Wall-hung WC and bidet with 560 mm projection. Universal WC toilet roll and brush holders in ceramic are also available.

Wand-WC und -Bidet mit 560 mm Ausladung. Universal WC-Rollen und Bürstenhalter aus Keramik sind ebenfalls erhältlich.

WC et bidet suspendus avec saillie de 560 mm. Des porte-papier et des porte-balai Universal en céramique sont également proposés.

Vaso e bidet sospesi con sporgenza di 560 mm. Sono disponibili anche il portascopino e il portarotolo Universal in ceramica.



Back-to-wall and floorstanding WC and bidet.

Wandbündiges und bodenstehendes WC und Bidet.

WC et bidet au sol et dos au mur.

Vaso e bidet a pavimento a filo muro.



Back-to-wall WC combination with Universal seat and cover and 305 mm vario outlet.

Wandbündige WC-Kombination mit Universal Sitz und Deckel und 305 mm-Vario-Abgang.

Installation de WC dos au mur avec siège et abattant de WC Universal et sortie Vario de 305 mm.

Vaso monoblocco a filo muro con sedile e coperchio Universal e scarico Vario da 305 mm.



Please find information about **Vario outlet** on page 56.

Informationen zur **Vario Abgang** finden Sie auf Seite 56.

Pour informations relatives à l'**évacuation Vario** voir sur page 56.

Per informazioni sul **scarico Vario** consultare pagina 56.



Compact dimensions, maximum comfort:
WC with 490 mm projection.

Kompakte Masse, maximaler Komfort:
WC mit 490 mm Ausladung.

Dimensions compactes, confort maximal:
WC avec saillie de 490 mm.

Dimensioni compatte, massima comodità:
vaso con sporgenza di 490 mm.



Renovation-friendly WC with raised and
normal seat position and horizontal outlet.

Renovierungsfreundliches WC mit erhöhter
und normaler Sitzposition und waagrechtem
Abgang.

WC pratique pour les rénovations avec posi-
tion assise normale et surélevée et sortie
horizontale.

Vaso di facile installazione con seduta norma-
le e rialzata e deflusso orizzontale.



Renovation-friendly WC with raised and
normal seat position and vertical outlet.

Renovierungsfreundliches WC mit erhöhter
und normaler Sitzposition und senkrechttem
Abgang.

WC pratique pour les rénovations avec posi-
tion assise normale et surélevée et sortie
verticale.

Vaso di facile installazione con seduta norma-
le e rialzata e deflusso verticale.

laufen^{pro} rimless WC



The bowl of the new LAUFEN pro rimless WC has no rim. There's no longer anywhere for dirt and deposits to hide; instead, thanks to an innovative and powerful flushing system, everything's flushed cleanly away with both 6/3 litre and the 4.5/3 litre cistern. Both public toilets and private bathrooms can benefit from the easy cleaning and great hygiene of this system.

Das neue LAUFEN pro rimless WC kommt ohne einen Spülrand aus. Schmutz und Anhaftungen finden hier keine Nische mehr, sondern werden dank eines innovativen, kraftvollen Spülsystems sowohl bei einer 6/3-Liter-Spülung als auch bei 4,5/3 Litern sauber weggespült. Von der vereinfachten Reinigung und dem Plus an Hygiene profitieren nicht nur öffentliche Sanitäreanlagen, sondern auch Privathaushalte.

Le nouveau WC LAUFEN pro rimless fonctionne sans rebord de rinçage. La saleté et les incrustations n'adhèrent plus, elles sont proprement rincées par un système de chasse d'eau puissant avec un volume de 6/3 litres ou 4,5/3 litres. Non seulement les installations sanitaires publiques, mais aussi les ménages en soi profitent du nettoyage simplifié et de l'hygiène accrue.

Il nuovo vaso LAUFEN pro rimless è senza brida. In questo modo la sporcizia e le incrostazioni non possono più aderire, ma vengono sciacquate perfettamente grazie ad un sistema di sciacquo potente e innovativo, sia da 6/3 litri che da 4,5/3 litri. La maggiore semplicità di pulizia e la maggiore igiene sono vantaggi importanti non solo negli impianti sanitari pubblici, ma anche in quelli domestici.



53 cm LAUFEN pro rimless WC



49 cm LAUFEN pro rimless WC compact

Hotel solutions

Practical solutions for hotel bathrooms.

Funktionelle Lösungen fürs Hotelbad.

Solutions fonctionnelles pour les salles de bains d'hôtel.

Soluzioni funzionali per i bagni degli hotel.





Public spaces





Its durability and high function, low-cost maintenance and outstanding value for money make LAUFEN pro the obvious choice for public spaces.

Langlebigkeit und hohe Funktionalität, wirtschaftlicher Unterhalt und ein ausgezeichnetes Preis-Leistungsverhältnis machen LAUFEN pro zur ersten Wahl im öffentlichen Bereich.

Longue durée de vie et grande fonctionnalité, entretien économique et excellent rapport qualité-prix – LAUFEN pro est le premier choix pour tous les espaces publics.

Grazie all'elevata funzionalità, alla durata nel tempo, alla ridotta manutenzione e ad un ottimo rapporto qualità/prezzo, LAUFEN pro è la soluzione ideale per gli ambienti pubblici.



Washbasin LAUFEN pro S with sensor-controlled curvetronic faucet.

Waschtische LAUFEN pro S mit sensor-gesteuerter curvetronic Armatur.

Lavabos LAUFEN pro S avec robinetterie activée par capteur curvetronic.

Lavabi LAUFEN pro S con rubinetto a sensori curvetronic.



Washbasin LAUFEN pro B with sensor-controlled faucet.

Waschtische LAUFEN pro B mit sensor-gesteuerter Armatur.

Lavabos LAUFEN pro B avec robinetterie activée par capteur.

Lavabi LAUFEN pro B con rubinetto a sensori.



Washbasin LAUFEN pro A with electronic faucet.

Waschtische LAUFEN pro A mit elektronischer Armatur.

Lavabos LAUFEN pro A avec robinetterie électronique.

Lavabi LAUFEN pro A con rubinetto elettronico.



LAUFEN urinals for 'public' sector can be seen in a wide variety of public places.

The caprino urinal flushes reliably with just one litre of water – also sensor-controlled and optionally available with the hygienic LCC ceramic coating. Matching rion urinal division for privacy.

Urinale von LAUFEN aus dem Bereich «public» kommen an den unterschiedlichsten öffentlichen Orten vor.

Das Urinal caprino spült sicher mit nur einem Liter Wasser – auch sensorgesteuert und optional mit der hygienischen Keramikveredelung LCC. Dazu passend die Urinal-Trennwand rion, die vor neugierigen Blicken schützt.

On trouve les urinoirs de LAUFEN de la gamme «public» dans les lieux publics les plus variés.

L'urinoir caprino permet un rinçage performant avec un litre d'eau seulement. Il existe également activé par un capteur et en option avec l'apprêtage de céramique hygiénique LCC. Assortie à la gamme, la paroi de séparation pour urinoir rion, qui protège des regards indiscrets.

Gli orinatoi LAUFEN della gamma «public» sono presenti nei più diversi luoghi pubblici.

L'orinatoio caprino consente un risciacquo sicuro con un solo litro d'acqua – anche con comando a sensori e su richiesta con rivestimento igienico LCC. In abbinamento è disponibile l'aletta divisoria rion, che protegge da sguardi indiscreti.

proliberty

Modern bathrooms suitable for wheelchair access translate convenience and function into good design. They play a considerable role in allowing people with special needs to lead more independent lives in their own homes.

LAUFEN pro liberty is an interesting proposition for private homes, hospitals, nursing and residential homes for the elderly. With its minimalist lines, it is perfectly matched to the LAUFEN pro bathroom suite series and, compliant with the standards, considerably increases comfort in bathroom use. LAUFEN pro liberty WC complies with DIN 18040 and SIA 521 500.

Moderne barrierefreie Bäder übersetzen Komfort und Funktion in gutes Design. Sie leisten einen wichtigen Beitrag zum selbstbestimmten Wohnen und Leben.

LAUFEN pro liberty ist für den Privathaushalt ebenso wie für Hospitäler, Pflege- und Seniorenheime eine interessante Lösung. Mit seiner reduzierten Linienführung passt es perfekt zur Komplettbadserie LAUFEN pro und macht die Badnutzung normgerecht erheblich komfortabler. Das LAUFEN pro liberty WC entspricht DIN 18040 und SIA 521 500.



Les salles de bains modernes accessibles aux personnes à mobilité réduite présentent à la fois confort et fonctionnalité dans un design agréable. Elles contribuent fortement à l'autonomie dans la vie quotidienne.

LAUFEN pro liberty est une solution intéressante aussi bien pour les particuliers que pour les hôpitaux, centres de soin et maisons de retraite. Avec ses lignes sobres, il se fond parfaitement dans la série complète LAUFEN pro et rend l'utilisation de la salle de bain nettement plus confortable tout en restant conforme aux normes posées. Le WC LAUFEN pro liberty respecte les normes DIN 18040 et SIA 521 500.

I nuovi bagni senza barriere architettoniche combinano comfort e funzionalità con un buon design e consentono un utilizzo autonomo anche da parte degli utenti con problemi motori. LAUFEN pro liberty è una soluzione interessante per le abitazioni private, gli ospedali, le case di cura e le case di riposo per anziani. Con la sua linea sobria, si combina perfettamente con la serie completa da bagno LAUFEN pro e rende molto più confortevole l'utilizzo del bagno, in conformità dalle normative vigenti. LAUFEN pro liberty rispetta le norme DIN 18040 e SIA 521 500.

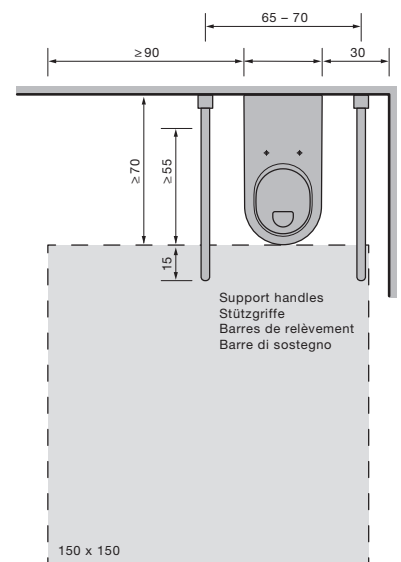

Flushdown WC, 700 mm projection, offering disabled access according to DIN 18040 and SIA 521 500.

Tiefspüler-WC, 700 mm Ausladung, barrierefrei nach DIN 18040 und SIA 521 500.

WC à chasse directe, saillie de 700 mm, adapté aux personnes à mobilité réduite selon DIN DIN 18040 et SIA 521 500.

Vaso a cacciata, sporgenza di 700 mm, senza barriere architettoniche in conformità alla norma DIN 18040 e SIA 521 500.



Please find information about **Laufen Clean Coat** on page 54.

Informationen zur **Laufen Clean Coat** finden Sie auf Seite 54.

Pour informations relatives à **Laufen Clean Coat** voir sur page 54.

Per informazioni su **Laufen Clean Coat** consultare pagina 54.

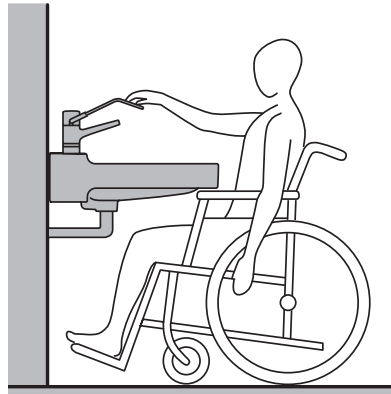

Wheelchair-ready washbasin offering disabled access according to DIN 18040, with or without overflow.

Unterfahrbarer Waschtisch barrierefrei nach DIN 18040, wahlweise mit oder ohne Überlauf.

Lavabo dégagé adapté aux personnes à mobilité réduite selon DIN 18040, au choix avec ou sans trop-plein.

Lavabo senza barriere architettoniche in conformità alla norma DIN 18040, a scelta con o senza troppopieno.



Ergonomic recessed handles on the underside of the washbasin help users pull themselves towards the washbasin and provide a secure hold.

Ergonomische Griffmulden am Waschtischboden für einfaches Heranziehen und Festhalten.

Poignées coquilles ergonomiques au pied du lavabo pour se hisser et se tenir en toute simplicité.

Maniglie ad incavo ergonomiche sul lato inferiore del lavabo per avvicinarsi e tenersi saldi facilmente.



The flexible lever on the liberty plus faucet can be comfortably operated by elbow, arm or back of the hand.

Der flexible Hebel der Armatur liberty plus kann bequem mit Ellbogen, Arm oder Handrücken bedient werden.

Le levier souple de la robinetterie liberty plus peut s'utiliser très confortablement avec le coude, le bras ou le dos de la main.

La leva flessibile del rubinetto liberty plus può essere utilizzata comodamente con il gomito, il braccio o il dorso della mano.



The WC seat position, raised by 6 cm, makes it easier for users to sit down and stand up, and allows correct posture when seated. It fits on standard connections (305 mm Vario).

Die um 6 cm erhöhte Sitzposition des WCs erleichtert das Hinsetzen und Aufstehen und ermöglicht eine körpergerechte Sitzhaltung. Es passt auf Standardanschlüsse (305 mm Vario).

La position assise du WC, surélevée de 6 cm, permet de s'asseoir et de se relever facilement et garantit un bon maintien du corps en position assise. Il est adapté aux raccords standards (305 mm Vario).

Grazie alla seduta del vaso rialzata di 6 cm, sedersi e rialzarsi è più facile e la posizione del corpo è più corretta. È predisposto per attacchi standard (305 mm Vario).



- Sitting position raised +6 cm for greater comfort
- Knee angle approx. 90° for correct sitting position and ease of getting up and sitting down
- +6 cm erhöhte Sitzposition für mehr Komfort
- Kniewinkel bei ca. 90° für ergonomisches Sitzen und einfaches Aufstehen und Absetzen
- Assise réhaussée de +6 cm pour plus de confort
- Angle du genou d'environ 90° pour une position plus adaptée et plus de confort au moment de s'asseoir et se relever

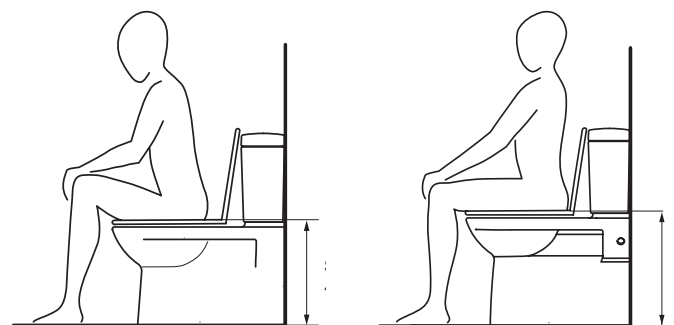

Standard
42 cm

Comfort
48 cm

- Seduta 6 cm più alta per maggior comfort
- Angolo ginocchia di 90° per una posizione più corretta e più comodità nel sedersi e rialzarsi

Furniture



LAUFEN pro S



White
Weiss
Blanc
Bianco



White glossy
Weiss glänzend
Blanc brillant
Bianco brillante



Wenge
Wenge
Wengé
Wengé



Graphite
Graphit
Graphite
Grafite

LAUFEN pro A + B



White
Weiss
Blanc
Bianco



White glossy
Weiss glänzend
Blanc brillant
Bianco brillante



Wenge
Wenge
Wengé
Wengé



Cappuccino
Cappuccino
Cappuccino
Cappuccino

Multicolor

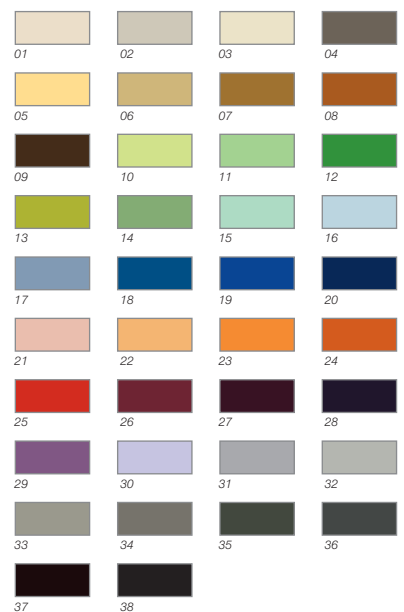



LAUFEN provides a wide range of colours for the LAUFEN pro furniture ranges using special matt paint finishes as well as the three standard decors: 38 colour tones especially created for LAUFEN allow the colours of your bathroom furniture to be coordinated with your bathroom.

Für die Möbelserie LAUFEN pro bietet LAUFEN eine grosse Farbauswahl an matten Sonderlacken zusätzlich zu den drei Standarddekoren: 38 eigens für LAUFEN kreierte Farbtöne ermöglichen die individuelle farbliche Abstimmung des Badmöbels auf ihr Bad.

Pour le série de meubles LAUFEN pro, LAUFEN propose un grand choix de couleurs de peinture spéciale satinée en plus des trois décors standard: 38 couleurs spécialement créées pour LAUFEN permettent de coordonner individuellement les meubles à votre salle de bains.

Per le serie di mobili LAUFEN pro, LAUFEN offre una grande selezione di colori con vernici speciali opache oltre alle tre decorazioni standard: 38 tonalità cromatiche create appositamente per LAUFEN permettono l'accordo cromatico dei mobili del bagno con il resto della vostra stanza.



The LAUFEN pro vanity units are fitted with a space-saving siphon. This dispenses with the need for siphon cut-outs in drawers, recovering valuable storage space.

Die LAUFEN pro Unterbaumöbel werden mit einem platzsparenden Siphon ausgestattet. Er macht Siphon-Ausschnitte in den Schubladen überflüssig und bringt wertvollen Stauraum zurück.

Les meubles LAUFEN pro sont munis d'un siphon prenant peu de place. Ce dernier rend superflues les découpes pour siphon dans les tiroirs, ce qui crée de la place de rangement supplémentaire.

Le basi sottolavabo LAUFEN pro sono dotate di un sifone salva-spazio, che rende superflui gli appositi tagli nei cassetti, consentendo un migliore sfruttamento del mobile.

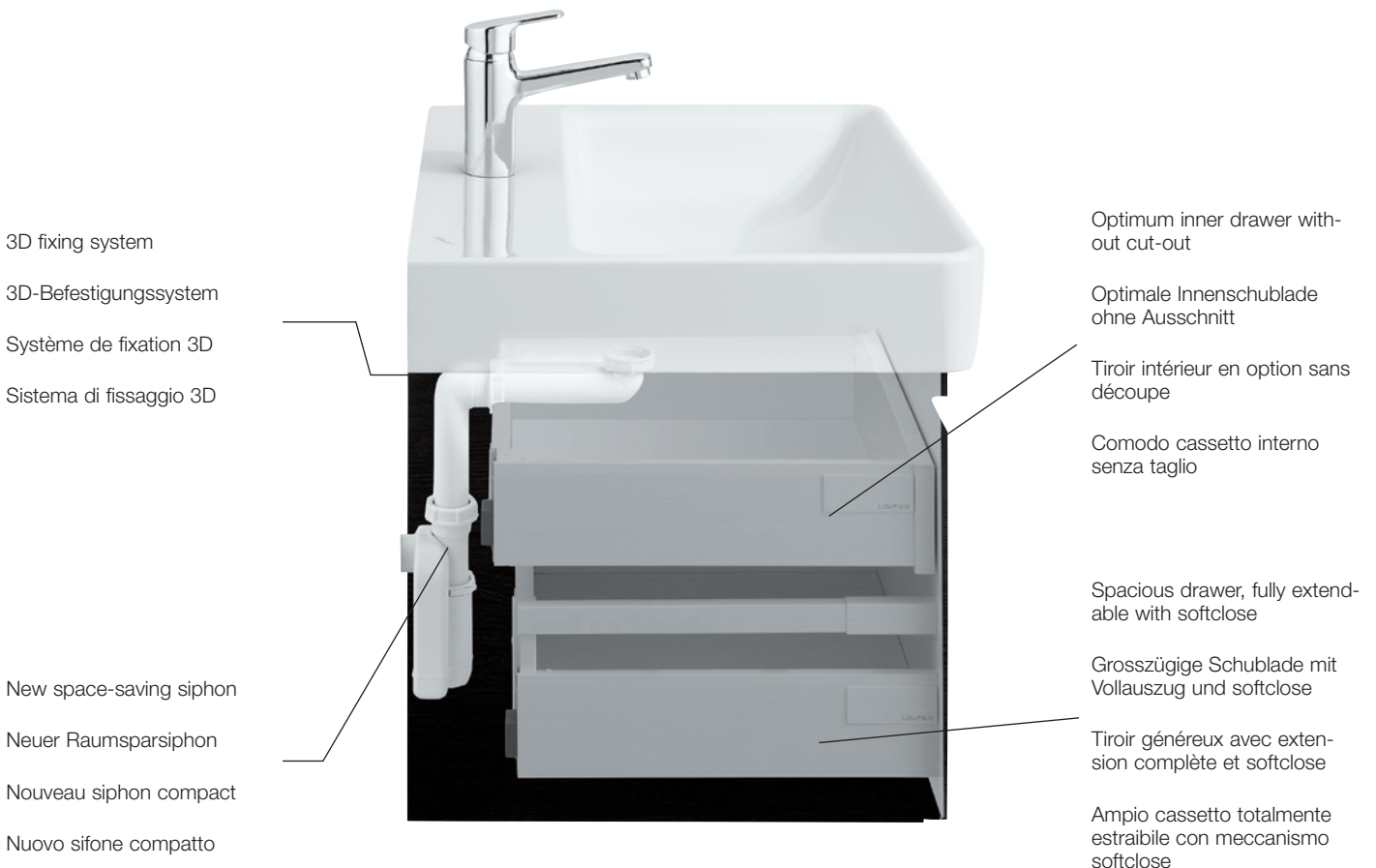

The integrated softclose mechanism and exclusive fittings ensure that drawers and doors always close gently and quietly.

Der integrierte softclose-Mechanismus und hochwertige Beschläge sorgen für dauerhaft sanftes und leises Schliessen der Schubladen und Türen.

Le mécanisme intégré de softclose et les raccords de grande qualité garantissent une fermeture silencieuse des tiroirs et portes sur le long terme.

Il meccanismo softclose e le cerniere di alta qualità consentono di chiudere sempre i cassetti e le ante in modo delicato e silenzioso.



Please find information about **softclose** on page 58.

Informationen zur **softclose** finden Sie auf Seite 58.

Pour informations relatives à **softclose** voir sur page 58.

Per informazioni su **softclose** consultare pagina 58.

Bathtubs



LAUFEN pro includes both acrylic and steel bathtubs. They are available in white or Pergamon and in a wide range of sizes. To provide greater comfort, the acrylic bathtubs can also be equipped with the whirl system.

Aussi bien des baignoires en acrylique qu'en acier font partie de LAUFEN pro. Elles sont disponibles dans les coloris blanc ou Pergamon et dans de nombreuses tailles. Les baignoires en acrylique peuvent être également équipées du système balnéo pour un confort absolu.

Zu LAUFEN pro gehören sowohl Acryl- als auch Stahlbade-
wannen. Sie sind in den Farben Weiss oder Pergamon sowie
in vielen Grössen erhältlich. Für gehobenen Komfort können
die Acrylwannen auch mit Whirlsystem ausgestattet werden.

La serie LAUFEN pro comprende le vasche da bagno in acrilico
e acciaio. Le vasche da bagno sono disponibili in bianco o per-
gamon e in molte misure. Per aumentare il comfort, le vasche
da bagno in acrilico possono anche essere equipaggiate con
sistema idromassaggio.



Please find information about **bathtub materials** on page 59.

Informationen zu **Wannenmaterialien** finden Sie auf Seite 59.

Pour informations sur les **matériaux de baignoire** voir sur page 59.

Per informazioni sui materiali delle **vasche da bagno**, consultare la pagina 59.



Lavish surfaces and a fascinating design are the stunning credentials of the cityplus faucet line. The new LAUFEN faucet collection celebrates urban living.

Grosszügige Flächen und ein faszinierendes Design zeichnen die Armaturen der Serie cityplus aus. Die neue Armaturensérie von LAUFEN versteht sich als Statement für urbanes Wohnen.

Les robinetteries de la série cityplus se caractérisent par des surfaces généreuses et un design fascinant. La nouvelle série de robinets complète de LAUFEN se définit comme un manifeste en faveur des intérieurs urbains.

Design raffinato e ampie superfici: questi i segni distintivi dei rubinetti cityplus. La nuova serie di rubinetteria di LAUFEN inneggia allo stile abitativo urbano.



reddot design award
winner 2013



Please find information about **European Water Label** on page 61.

Informationen zum **European Water Label** finden Sie auf Seite 61.

Pour informations relatives à **European Water Label** voir sur page 61.

Per informazioni su **European Water Label** consultare pagina 61.

citypro



Enduring style for the bathroom: Fascinating design paired with outstanding functionality. Elegant and hand-hugging shapes. The citypro range of faucets entirely captures the zeitgeist of contemporary home décor. Their unadorned design and individuality lends the bathroom a minimalist touch.

Zeitlose Formensprache für das Bad: Faszinierendes Design und hohe Funktionalität. Elegante und handschmeichelnde Formen. Die Armaturenserie citypro trifft den Zeitgeist der modernen Wohnkultur. Ihre Schlichtheit und Individualität verleiht dem Badezimmer eine puristische Note.

Un langage formel intemporel pour la salle de bain: Design fascinant et grande fonctionnalité. Formes élégantes et douces à la main. La série de robinetteries citypro est parfaitement en phase avec son temps et une culture d'habitation moderne. Sa sobriété et son individualité confèrent à la salle de bain une note de pureté.

Please find information about **Ecototal** on page 60.

Informationen zu **Ecototal** finden Sie auf Seite 60.

Pour informations relatives à **Ecototal** voir sur page 60.

Per informazioni su **Ecototal** consultare pagina 60.

L'eterno linguaggio delle forme per il bagno: Un design seducente ed elevata funzionalità. Forme eleganti e carezzevoli. La serie di rubinetti citypro soddisfa completamente lo spirito del tempo della moderna cultura del living. La sua sobrietà e la sua individualità conferiscono alla sala da bagno una nota purista.



Product features and benefits: Sanitary ware

LCC stands for **Laufen Clean Coat**. This innovative ceramic surface finish is a vitreous silicate ceramic coating which is fired on top of the original glaze. LCC is an extremely hard, indeed almost indestructible indivisible part of the ceramic object to which it is applied.

The benefits of this process: With a roughness of only 4 nanometers, LCC is entirely free of pores. Thanks to this feature, lime, dirt and bacteria have practically nowhere to gain a foothold – and even if they do, they can be removed much more easily. A hydrophilic effect caused by the material ensures that dirt particles are more easily washed away on flushing. In addition, cleaning and disinfection fluids spread over the surface more easily and thus work more effectively. This is an ideal solution for the rigorous demands of everyday cleaning – for example in hotels or clinics.

LCC steht für **Laufen Clean Coat**. Diese innovative Keramik-Oberflächenveredelung ist ein silikatkeramischer, glasartig eingebrannter Überzug über die Originalglasur. Als untrennbarer Bestandteil der Keramik ist LCC extrem hart und nahezu unverwundlich.

Die Vorteile dieses Verfahrens: LCC ist mit einem Rauheitswert von nur vier Nanometern porenfrei. Dank dieser Eigenschaft finden Kalk, Schmutz und Bakterien kaum Halt – und wenn doch, dann lassen sich Verschmutzungen wesentlich leichter wieder entfernen. Es tritt ein hydrophiler Effekt auf, der dafür sorgt, dass beim Abspülen Schmutzpartikel leichter weggespült werden. Auch Reinigungs- und Desinfektionsmittel verteilen sich einfacher und wirken somit effizienter. Eine ideale Lösung für den harten Reinigungsalltag – beispielsweise in Hotels oder Kliniken.

LCC est l'abréviation de la désignation **Laufen Clean Coat**.

Ce traitement innovant de la surface céramique consiste en un revêtement céramique à base de silicate vitreux cuit sur le vernis d'origine. Le revêtement LCC fait partie intégrante de la céramique et en tant que tel, est extrêmement résistant et pratiquement inusable.

Les avantages de ce procédé: avec une valeur de rugosité de seulement quatre nanomètres, le LCC est exempt de pores. Grâce à cette propriété, le calcaire, les particules de saleté et les bactéries n'adhèrent pas – et même lorsque c'est le cas, les saletés sont bien plus faciles à retirer. Un effet hydrophile agit de sorte que les particules de saleté partent plus facilement au rinçage. Les produits de nettoyage et de désinfection s'étalent plus facilement et agissent ainsi de manière plus efficace. Une solution idéale pour répondre aux sollicitations impitoyables que représente le nettoyage quotidien – par exemple dans les hôtels ou les cliniques

LCC significa **Laufen Clean Coat**. Questa preziosa innovazione fornisce alla ceramica un rivestimento a base di silicati, che viene vetrificato sopra lo smalto originale. Essendo un componente inseparabile della ceramica, LCC risulta estremamente duro e pressoché indistruttibile.

I vantaggi di questo procedimento: con una ruvidità di soli quattro nanometri LCC è del tutto privo di pori. Grazie a questa caratteristica lo sporco, il calcare e i batteri non fanno presa e sono quindi molto facili da rimuovere, anche solo con l'acqua. L'effetto idrofilo che si verifica consente di lavare via più facilmente le particelle di sporco con un semplice risciacquo. Una soluzione ideale per la faticosa pulizia quotidiana, ad esempio in hotel o nelle cliniche.



The innovative glazing for durable hygiene.
Die innovative Glasur für dauerhafte Hygiene.
L'email innovant pour l'hygiène durable.
Lo smalto innovativo per un'igiene duratura.



2012

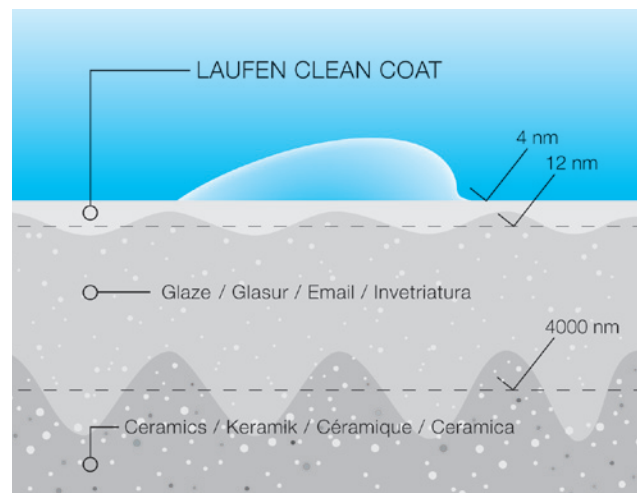



LAUFEN has developed a revolutionary wall fixation system for WCs, bidets and urinals. A patent has been lodged. The invisible, easy to mount fixation system meets the needs of both fitters and end users. For example, end users are impressed by a ceramic WC with a flawless surface which is really easy to clean since there's nowhere for dirt to hide. Fitters are enthusiastic about the time-saving, intuitive mounting system.



LAUFEN hat eine revolutionäre Wand-Befestigung für WCs, Bidets und Urinale entwickelt und zum Patent angemeldet. Diese unsichtbare und einfach zu montierende Befestigung entspricht den Bedürfnissen von Installateuren und Endanwendern gleichermaßen. Die Endanwender freuen sich zum Beispiel über ein Keramik-WC, dessen makellose Oberfläche sich mühelos reinigen lässt, da der Schmutz keinen Halt in Nischen findet. Die Installateure begeistern sich für das zeitsparende, selbst-erklärende Montagesystem.



LAUFEN a développé une fixation murale révolutionnaire pour WC, bidets et urinoirs et a déposé un brevet pour celle-ci. Cette fixation facile à monter et invisible satisfait aux exigences des installateurs et de l'utilisateur final. L'utilisateur final apprécie par ex. d'avoir acheté un WC en céramique, dont la surface irréprochable se nettoie sans peine, étant donné que la saleté n'adhère plus dans les coins. Les installateurs apprécient le système de montage rapide et intuitif.



LAUFEN ha messo a punto un rivoluzionario sistema di fissaggio a parete (in fase di brevetto) per vasi, bidets ed orinatoi. Questo sistema di fissaggio invisibile e facile da montare soddisfa in egual misura le esigenze degli installatori e degli utenti finali. L'utente finale sarà sicuramente soddisfatto di un vaso in ceramica estremamente facile da pulire, in quanto la sporcizia non riesce ad aderire nelle nicchie. Gli installatori invece apprezzeranno la possibilità di risparmiare tempo con questo sistema di montaggio autoesplicativo.

Product features and benefits: Sanitary ware

The installation dimensions of WCs are not always identical: In many renovation situations the LAUFEN **Vario outlet** can make it easier to connect the WC to the sewage network. Both horizontal and vertical outlet wall clearances of up to 350 mm for washout and 305 mm for washdown are possible.

Die Anschlussmasse von WCs sind nicht immer gleich: In vielen Renovierungssituationen erleichtert der **Vario-Abgang** von LAUFEN den sicheren Anschluss des WCs an das Abwassernetz. Sowohl ein waagrechter als auch ein senkrechter Abgang mit Wandabständen bis zu 350 mm beim Flach- und 305 mm beim Tiefspüler sind damit möglich.

Les dimensions de raccordement des WC ne sont pas toujours les mêmes: dans de nombreuses situations de rénovation, la **sortie Vario** de LAUFEN permet le raccordement en toute sécurité du WC au réseau d'évacuation. Elle permet aussi bien une sortie horizontale que verticale avec des distances par rapport au mur allant jusqu'à 350 mm pour la chasse à fond plat et 305 mm pour la chasse directe.

Le misure di attacco dei WC non sono sempre identiche: In diverse situazioni di ristrutturazione lo **scarico Vario** di LAUFEN facilita l'attacco sicuro del WC alla rete di acque reflue. Sono pertanto possibili sia uno scarico verticale sia uno orizzontale con distanze massime dalle pareti pari a 350 mm a fondo piatto e a 305 mm a cacciata.



Maximum wall clearance for vertical floor outlet

Maximaler Wandabstand für senkrechten Bodenabgang

Distance maximale par rapport au mur pour une sortie au sol verticale

Massima distanza dalla parete per scarico a fondo verticale



Minimum wall clearance for vertical floor outlet

Minimaler Wandabstand für senkrechten Bodenabgang

Distance minimale par rapport au mur pour une sortie au sol verticale

Minima distanza dalla parete per scarico a fondo verticale



Horizontal wall outlet

Waagrechter Wandabgang

Sortie murale horizontale

Scarico a parete orizzontale

The latest generation of LAUFEN water-saving WCs is optimised to flush with two reduced flushing volumes: 4.5 or 3 litres of water. Compared to today's 6/3 litre dual flush or 6 litre single flush standard, these new models provide substantial water savings.

LAUFEN products marked with the green 4.5/3L logo are not only fulfilling the requirements defined in the harmonized standard EN 997 Class 1 Type 5 and Class 2 (that cover the whole European territory), but also fulfill the challenging Australian requirements of SAI/Wells 4 Stars.

In order to achieve this water saving the LAUFEN floor-standing WC combination shall be combined with its dedicated cistern having the option .75x. LAUFEN wall-hung or floor-standing WCs shall be combined with any concealed cistern, locally available and approved for 4.5/3 litre flushing. Please note that a suitable downstream drainage system must be built for this kind of water-saving WCs. In case of restrictions of the existing drainage system or local regulations LAUFEN WCs marked with the green 4.5/3L logo can also be flushed with standard 6 litre flushing volume.

Die neueste Generation von LAUFEN Wasserspar-WCs ist auf das Spülen im Zweimengen-Spülsystem mit 4,5 bzw. 3 Litern optimiert. Gegenüber den in Bestandgebäuden meistens verwendeten Versionen mit 6/3L oder 6L Spülung erreichen diese Modelle eine erhebliche Einsparung. LAUFEN erfüllt mit den mit einem grünen 4,5/3L Logo markierten Produkten nicht nur die geltenden Normen nach EN 997 Class 1 Type 5 und EN 997 Class 2 (europäischer Raum), sondern auch die in anderen Ländern geltenden Vorgaben (u.a. die austr. SAI/Wells 4-Zertifikate).

Um diese Wassereinsparung zu erreichen, müssen die LAUFEN Stand-WC-Kombinationen mit Spülkästen der Option .75x kombiniert werden. LAUFEN Wand- oder Stand-WCs können mit jedem Unterputz-Spülkasten kombiniert werden, der die 4,5/3L Norm erfüllt. Zu beachten ist dabei, dass das Abwassersystem des Gebäudes auf diese Wasserspar-WCs ausgelegt sein muss. Im Falle einer Einschränkung durch das Abwassersystem oder durch lokale gesetzliche Bestimmungen, können LAUFEN WCs mit dem 4,5/3L Logo auch mit 6-L Spülung betrieben werden.



Thanks to our convenient **lowering system** many of our WC covers and seats close gently and quietly. For easier cleaning, all LAUFEN seats can be removed with a simple hand movement. LAUFEN seats have been comprehensively tested: amongst others the test includes opening and closing 50,000 times.

LAUFEN WC-Sitze und -Deckel bieten dem Anwender viele Vorteile: So können alle WC-Sitze von LAUFEN für eine einfache und gründliche Reinigung mit einem Handgriff abgenommen werden. Umfangreiche Tests, zum Beispiel 50.000-faches Öffnen und Schliessen, bürgen für beste Qualität. Und viele WC-Sitze und -Deckel von LAUFEN schliessen dank komfortabler **Absenkautomatik** sanft und leise.



Grâce à leur confortable **abaissement automatique**, de nombreux sièges et abattants de WC LAUFEN descendent lentement et en silence sur la cuvette. Et pour qu'on puisse les nettoyer sans peine, siège et abattant s'enlèvent en un tour de mains. Les sièges de WC LAUFEN sont soumis à des tests très complets: entre autres, le test comportant 50 000 ouvertures et fermetures.

Grazie al **sistema di caduta rallentata** molti coperchi per WC e sedili per WC di LAUFEN si chiudono in modo delicato e silenzioso. Per una pulizia agevole, tutti i sedili per WC LAUFEN sono rimovibili con un semplice movimento. I sedili per WC LAUFEN vengono testati in modo particolarmente accurato: tra l'altro devono superare un test consistente in 50.000 aperture e chiusure.



La dernière génération des WC économes en eau LAUFEN est optimisée pour le système de rinçage à deux quantités avec 4,5 ou 3 litres. Par rapports aux versions utilisées le plus souvent dans les bâtiments existants avec un rinçage de 6/3 litres ou de 6 litres, ces modèles permettent une économie importante.

Avec les produits marqués d'un logo vert 4,5/3 litres, LAUFEN ne satisfait pas seulement aux normes en vigueur selon EN 997 classe 1 type 5 et EN 997 classe 2 (espace européen) mais également aux spécifications valables dans d'autres pays (notamment aux certificats SAI/Wells 4). Afin d'atteindre cette économie d'eau, les combinaisons des WC sur socle LAUFEN doivent utiliser des réservoirs de l'option .75x. Les WC suspendus ou sur socle LAUFEN peuvent être combinés avec tous les réservoirs encastrés qui répondent à la norme 4,5/3 litres. Il faut savoir à ce sujet que le système d'évacuation du bâtiment doit être dimensionné en fonction de ces WC économes en eau. En cas de restriction relative au système d'évacuation ou aux dispositions locales en vigueur, les WC LAUFEN munis du logo 4,5/3 litres peuvent être également exploités avec un rinçage de 6 litres.

La nuova generazione di WC a risparmio idrico LAUFEN ottimizza lo sciacquone attraverso un sistema a duplice quantità da 4,5 o 3 litri. Rispetto alle versioni per lo più utilizzate negli edifici esistenti, con sciacquoni da 6/3 litri o 6 litri, questi modelli consentono un notevole risparmio.

I prodotti contrassegnati con un logo verde da 4,5/3 litri della serie LAUFEN non solo soddisfano le norme applicabili ai sensi della EN 997 Classe 1 tipo 5 e EN 997 Classe 2 (ambito europeo), bensì anche le prescrizioni applicabili in altri Paesi (compresi i certificati austr. SAI/Wells 4).

Per ottenere questo risparmio d'acqua, i vasi monoblocco a pavimento LAUFEN devono essere abbinati alle cassette di sciacquo dell'opzione da 0,75x. I vasi sospesi o i vasi monoblocco a pavimento della serie LAUFEN possono essere combinati con qualsiasi cassetta di sciacquo da incasso, che soddisfa lo standard 4,5/3 litri. Occorre tenere in considerazione che il sistema di acqua di scarico dell'edificio deve essere concepito appositamente per questo WC a risparmio idrico. In caso di limitazioni dovute alla rete fognaria o alle disposizioni locali in vigore, i WC della serie LAUFEN con il logo da 4,5/3 litri possono essere utilizzati anche con sciacquoni da 6 litri.

Product features and benefits: Furniture

Slamming of doors is not inevitable: At LAUFEN, **softclose** means gently-closing furniture doors and drawers. The system is integrated as standard into all LAUFEN furniture. In this case, quality can be felt and not heard.

Türenschiagen muss nicht sein: **softclose** steht bei LAUFEN für gedämpfte Möbeltüren und Schubladen und ist standardmässig in allen LAUFEN Möbeln umgesetzt. Hier wird Qualität spür- und eben nicht mehr hörbar.

Claquer les portes n'est pas une fatalité: chez LAUFEN, la désignation **softclose** est synonyme de technique de fermeture en douceur des portes et des tiroirs. Cette technique équipe en série tous les meubles LAUFEN. Ici la qualité est perceptible mais inaudible.

La porta non deve sbattere: **softclose** viene utilizzato da LAUFEN per le porte dei mobili e per i cassetti ammortizzati ed è uno standard applicato a tutti i mobili LAUFEN. In questo modo la qualità diventa evidente ma silenziosa.



Comfort in every detail: The flexible and adjustable **3D mounting system** makes installation of LAUFEN furniture on the wall quick and easy.

Komfort bis ins Detail: Mit einem flexibel einstellbaren **3D-Befestigungssystem** ist die Wandmontage der LAUFEN Möbel unkompliziert und schnell.

Le confort jusque dans les détails: avec un **système de fixation à réglage modulaire 3D**, le montage mural des meubles LAUFEN est simple et rapide.

Comfort fin nei minimi dettagli. Con un flessibile **sistema di fissaggio 3D** regolabile il montaggio a parete dei mobili LAUFEN risulta semplice e rapido.



Product features and benefits: Bathtubs

In order to be able to provide the right solution for all situations, LAUFEN offers in the LAUFEN pro series bathtubs in two different materials. When choosing the **bathtub material** the choice depends on individual preference and intended use.

Acrylic bathtubs:

bathtubs made of sanitary acrylic have benefits due to the insulating properties of the material and its warm surface. Together with an underlay made of hard foam, the material helps your bath water retain its temperature for a long time. LAUFEN sanitary acrylic is integrally coloured, is light- and colour-fast and easy to clean.

Steel bathtubs:

bathtubs in enamelled steel are hygienic, and resistant to acid, scratching, impacts and abrasion. LAUFEN steel bathtubs are produced using heavy 3 and 3.5 mm enamelled steel; they are extremely dimensionally stable and come with an anti-slip coating. In addition, they can be fitted with an optional structural sound insulation system.

Um in allen Fällen die richtige Lösung anzubieten, bietet LAUFEN in der Serie LAUFEN pro zwei verschiedene Wannenmaterialien. Bei der Wahl des **Wannenmaterials** ist die Entscheidung abhängig von der individuellen Präferenz und dem geforderten Anwendungsfall.

Acryl-Badewannen:

Badewannen aus Sanitäracryl haben ihre Vorteile in der guten Isolationsfähigkeit des Werkstoffs und seiner warmen Oberfläche. Zusammen mit einem Wannenträger aus Hartschaumstoff hält das Badewasser darin lange Zeit seine Temperatur. LAUFEN Sanitäracryl ist durchgefärbt, licht- und farbecht, sowie reinigungsfreundlich.

Stahl-Badewannen:

Badewannen aus emailliertem Stahl sind hygienisch, säurebeständig, kratz-, schlag- und abriebfest. LAUFEN Stahlwannen werden aus schwerem 3 und 3,5 mm dickem Stahl-Email gefertigt, sind extrem formstabil und mit der Antislip-Beschichtung erhältlich. Zudem verfügen sie optional über einen konstruktiven Schallschutz.



Pour offrir la bonne solution dans tous les cas, LAUFEN propose deux différents matériaux de baignoire dans la serie LAUFEN pro. Le choix **des matériaux de baignoire** se fait en fonction des préférences individuelles et du cas d'application exigé.

Baignoires acryliques:

L'avantage des baignoires en acrylique sanitaire tient à la bonne capacité d'isolation de ce matériau et à sa surface chaude. En combinaison avec un support de baignoire en mousse rigide, l'eau du bain conserve longtemps sa température. L'acrylique sanitaire LAUFEN est teintée dans la masse, sa couleur grand teint résiste à la lumière, et est facile à nettoyer.

Baignoires en acier:

Les baignoires en acier émaillé sont hygiéniques, résistants aux acides, aux rayures et à l'abrasion. Les baignoires en acier LAUFEN sont fabriquées en acier émaillé d'une épaisseur de 3 et 3,5 mm, elles sont indéformables et disponibles avec le revêtement antislip. Elles possèdent en outre une isolation acoustique en option.

Per offrire sempre la soluzione più adatta, LAUFEN offre le sue vasche della serie LAUFEN pro in due materiali diversi. Nella scelta della **materiali delle vasche da bagno** la decisione dipende dalle preferenze individuali e dagli ambiti di applicazione.

Vasche da bagno in acrilico:

Le vasche da bagno di acrilico sanitario hanno il loro punto di forza nella buona capacità di isolamento del materiale e nella loro superficie calda. Insieme a un supporto di materiale espanso, l'acqua del bagno mantiene per lungo tempo la sua temperatura. L'acrilico sanitario LAUFEN è colorato, adatto alla luce e ad ambienti vivaci ed è facile da pulire.

Vasche da bagno in acciaio:

Le vasche da bagno in acciaio smaltato sono igienici, resistenti agli acidi, antigraffio, antiurto e antiabrasione. Le vasche in acciaio LAUFEN sono fabbricate in acciaio smaltato con spessore di 3 e 3,5 mm, sono estremamente stabili e disponibili con rivestimento antiscivolo. Inoltre dispongono come optional di una protezione acustica integrata.



Product features and benefits: Faucets

Saving water and energy without compromising comfort – this is the speciality of the **Ecototal** and **Ecototal+** energy-saving technologies used in LAUFEN faucets. The ceramic control cartridges within the faucets contain flow and temperature regulators – in order to draw off the full quantity of water or really hot water, a certain resistance must be overcome when opening the faucet. Using this LAUFEN technology, up to a third of energy and water consumption can be saved without compromising comfort. Ecototal+ also provides an intuitive energy-saving function which is ideal for public sanitary facilities: When the lever is in the centre position, only cold water and not mixed water is drawn off – which is often sufficient when washing hands.

Wasser- und Energiesparen ohne Komfortverlust – dafür stehen die Wasser- und Energiesparttechnologien **Ecototal** und **Ecototal+** in LAUFEN Armaturen. Die keramischen Steuerkartuschen in den Armaturen haben eine Mengen- und Heisswasserbremse – um die volle Wassermenge oder echtes Heisswasser zu zapfen, muss erst ein Widerstand überwunden werden. Mit dieser LAUFEN Technik lässt sich ohne Komfortverlust bis zu einem Drittel Energie und Wasser sparen. Ecototal+ bietet obendrein eine intuitive Energiesparfunktion – ideal für öffentliche Sanitäranlagen: In der Mittelstellung des Hebels wird kein Mischwasser gezapft, sondern nur kaltes Wasser – was für das Händewaschen ja genügt.

Les technologies d'économie d'eau et d'énergie **Ecototal** et **Ecototal+** des robinetteries LAUFEN permettent d'économiser de l'eau et de l'énergie sans perte de confort. Les cartouches de commande en céramique des robinetteries sont équipées d'un réducteur de débit et d'eau chaude. Pour tirer la quantité d'eau complète ou de l'eau vraiment chaude, une résistance doit tout d'abord être surmontée. Cette technique LAUFEN permet d'économiser jusqu'à un tiers de l'énergie et de l'eau sans perte de confort. Ecototal+ offre en outre une fonction d'économie d'énergie intuitive, idéale pour les sanitaires publics: en position médiane du levier, aucune eau combinée n'est tirée mais seulement de l'eau froide, ce qui est suffisant pour se laver les mains.

Risparmio idrico ed energetico senza riduzione del comfort – questo è lo scopo delle tecnologie di risparmio idrico e energetico **Ecototal** e **Ecototal+** nella rubinetteria LAUFEN. Le cartucce di controllo nella rubinetteria hanno un limitatore della quantità e della temperatura dell'acqua: per erogare la massima quantità d'acqua o esclusivamente l'acqua calda occorre prima superare una resistenza. Con questa tecnica offerta da LAUFEN è possibile risparmiare fino a un terzo di energia e di acqua senza ridurre il comfort. Ecototal+ offre inoltre una funzione di risparmio energetico – ideale per impianti sanitari pubblici: Nella posizione centrale della leva non viene spillata acqua miscelata, ma soltanto acqua fredda – che va già bene per lavarsi le mani.

Ecototal

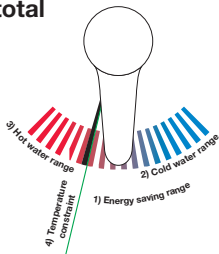

Ecototal / Ecototal+

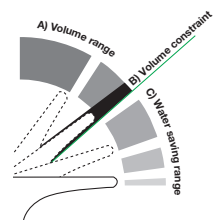

Ecototal+

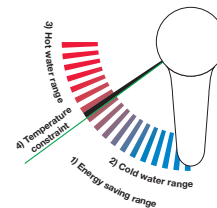

The **Simibox** is a practical universal concealed mounting unit by LAUFEN. Apart from allowing easy and secure installation of faucets, it also allows the concealed mixer to be inspected later on – without having to shut off the main stopcock. The Simibox is suitable for any building project. The installation process remains largely the same no matter what construction method is being used.

Die **Simibox** ist die praktische Universal-Unterputz-Montageeinheit von LAUFEN. Neben einer sicheren und einfacheren Montage der Armaturen ist mit ihr eine unkomplizierte spätere Revision des Unterputzmischers möglich – ohne Abstellen des Hauptwasserhahns. Die Simibox eignet sich grundsätzlich für jedes Bauvorhaben. Der Arbeitsablauf bleibt ungeachtet der Einbauart weitgehend derselbe.

La **Simibox** est l'ensemble pratique de montage universel encastré de LAUFEN. Outre un montage sûr et aisé des robinetteries, elle permet une révision ultérieure facile du mitigeur encastré sans arrêter le robinet d'eau principal. La Simibox est conçue par principe pour toutes les constructions. La séquence de travail est pratiquement la même quel que soit le type de construction.

Simibox è la pratica unità di montaggio da incasso universale LAUFEN. Oltre a consentire un montaggio semplice e sicuro, con essa è possibile una facile successiva manutenzione del miscelatore da incasso, senza spostare il rubinetto dell'acqua principale. Simibox si adatta fundamentalmente ad ogni struttura. Il lavoro si svolge allo stesso modo indipendentemente dal tipo di installazione.

The European labelling voluntary scheme to improve the water consumption and performance of faucets, valves & shower heads.

The scheme provides easy access to a database of bathroom products which when installed and used correctly will use less water, save energy and save money.

Das freiwillige europäische Kennzeichnungssystem zur Verbesserung des Wasserverbrauchs und der Leistung von Armaturen, Ventilen und Duschköpfen.

Das System bietet einfachen Zugang zu einer Datenbank mit Bad-Produkten, die bei korrekter Installation und Verwendung weniger Wasser verbrauchen und Energie sowie Geld sparen.

Le système d'étiquetage volontaire européen en vue de l'amélioration de la consommation d'eau et des performances des robinets, des vannes et des pommes de douche.

Le système offre un accès facile à une base de données de produits pour la salle de bains qui, à condition qu'elle soit correctement installée et utilisée, permettent de réduire la consommation d'eau et d'économiser de l'énergie et ainsi de l'argent.

Il programma europeo di etichettatura facoltativa ridurrà il consumo di acqua e migliorerà le prestazioni di rubinetti, valvole e bulbi doccia.

Il programma fornisce un facile accesso ad un database di prodotti per il bagno che, se installati ed utilizzati correttamente, utilizzano una minore quantità d'acqua, e aiutano a risparmiare energia e a ridurre i costi.

Washbasin and bidet mixers:

- curveplus
- twinplus
- cityplus
- Kartell by LAUFEN

Handshowers:

- MyCity
- MyTwin
- SatinJet

Type of measurement

Art der Messung

Type de mesure

Tipo di misurazione

Performance bands

Performance-Wert

Valeur de performance

Valore di prestazione

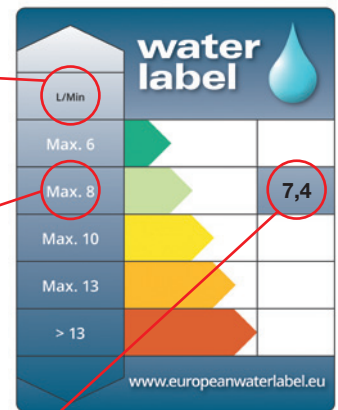

Actual capacity or performance of the manufacturers product

Tatsächliche Kapazität oder Leistung des Produkts des Herstellers

Capacité ou performances actuelles du produit du fabricant

Capacità o prestazioni effettive del prodotto del fabbricante

Source / Quelle / source / origine:
<http://www.europeanwaterlabel.eu>

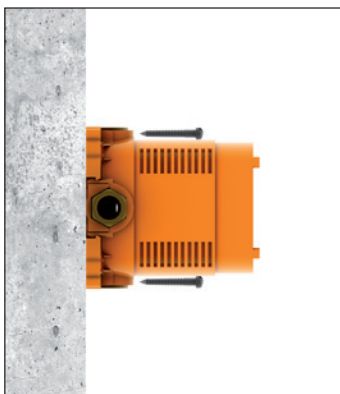

On-wall installation
 Vorwand-Montage
 Montage sur le mur
 Montaggio davanti alla parete

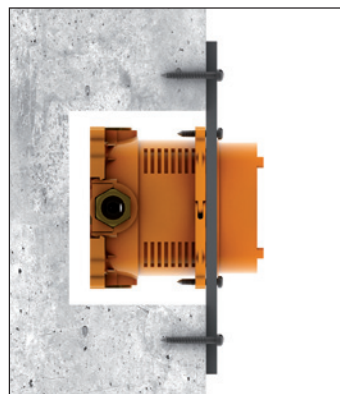

In-wall installation
 Inwand-Montage
 Montage dans le mur
 Montaggio in parete

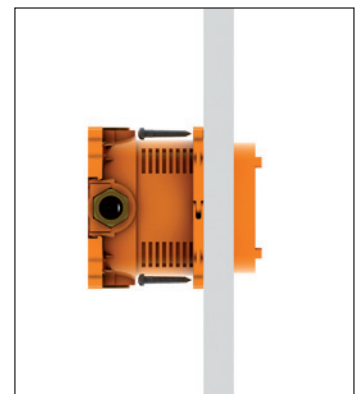

Behind-wall installation
 Hinterwand-Montage
 Montage derrière le mur
 Montaggio dietro alla parete



81596.0 ○/●
Small washbasin, asymmetric
Handwaschbecken, asymmetrisch
Lave-mains, asymétrique
Lavamani, asimmetrico

Options:
 .104 .109

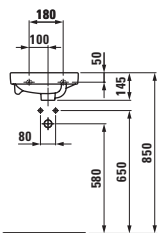
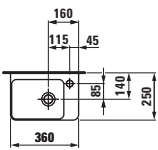

81595.4 ○/●
Small washbasin, asymmetric right
Handwaschbecken, asymmetrisch rechts
Lave-mains, asymétrique droit
Lavamani, asimmetrico destro

Options:
 .104 .109

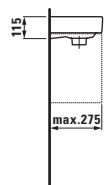
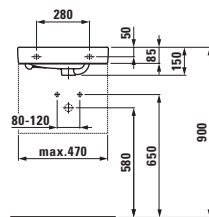
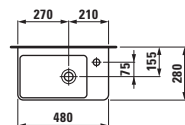

81595.5 ○/●
Small washbasin, asymmetric left
Handwaschbecken, asymmetrisch links
Lave-mains, asymétrique gauche
Lavamani, asimmetrico sinistro

Options:
 .104 .109

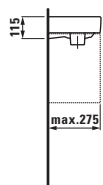
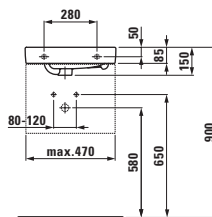
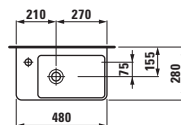

81596.1 ○/●
Small washbasin
Handwaschbecken
Lave-mains
Lavamani

81996.4
Siphon cover, ceramic
Siphonverkleidung, Keramik
Cache siphon, céramique
Coprisifone, ceramica

81696.1 ○/●
Small washbasin, undersurface ground
Aufsatz-Handwaschbecken, wandmontiert
Lave-mains, face inférieure meulée
Lavamani, superficie inferiore levigata

Options:
 .104 .109 .111 .112 .142 .156

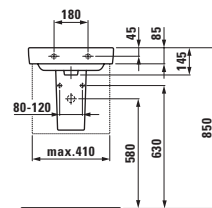
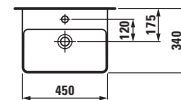

LAUFEN pro S



81096.2 ○/●/●●●*
Washbasin
 Waschtisch
 Lavabo
 Lavabo

81996.2
Pedestal, ceramic
 Säule, Keramik
 Colonne, céramique
 Colonna, ceramica

81996.3
Siphon cover, ceramic
 Siphonverkleidung, Keramik
 Cache siphon, céramique
 Coprisifone, ceramica

81696.2 ○/●/●●●
Washbasin, undersurface ground
 Aufsatz-Waschtisch, wandmontiert
 Lavabo, face inférieure meulée
 Lavabo, superficie inferiore levigata

Options:
 .104 .108 not available with siphon cover .109 .111 .112 .136 .142 .156 .158





81096.3 ○/●/●●●*
Washbasin
 Waschtisch
 Lavabo
 Lavabo

81996.2
Pedestal, ceramic
 Säule, Keramik
 Colonne, céramique
 Colonna, ceramica

81996.3
Siphon cover, ceramic
 Siphonverkleidung, Keramik
 Cache siphon, céramique
 Coprisifone, ceramica

81696.3 ○/●/●●●
Washbasin, undersurface ground
 Aufsatz-Waschtisch, wandmontiert
 Lavabo, face inférieure meulée
 Lavabo, superficie inferiore levigata

Options:
 .104 .108 not available with siphon cover .109 .111 .112 .136 .142 .156 .158





81096.4 ○/●/●●●*
Washbasin
 Waschtisch
 Lavabo
 Lavabo

81996.2
Pedestal, ceramic
 Säule, Keramik
 Colonne, céramique
 Colonna, ceramica

81996.3
Siphon cover, ceramic
 Siphonverkleidung, Keramik
 Cache siphon, céramique
 Coprisifone, ceramica

81696.4 ○/●/●●●
Washbasin, undersurface ground
 Aufsatz-Waschtisch, wandmontiert
 Lavabo, face inférieure meulée
 Lavabo, superficie inferiore levigata

Options:
 .104 .108 not available with siphon cover .109 .111 .112 .136 .142 .156 .158





81096.7 ○/●/●●●*
Washbasin
 Waschtisch
 Lavabo
 Lavabo

81996.2
Pedestal, ceramic
 Säule, Keramik
 Colonne, céramique
 Colonna, ceramica

81996.3
Siphon cover, ceramic
 Siphonverkleidung, Keramik
 Cache siphon, céramique
 Coprisifone, ceramica

81696.7 ○/●/●●●
Washbasin, undersurface ground
 Aufsatz-Waschtisch, wandmontiert
 Lavabo, face inférieure meulée
 Lavabo, superficie inferiore levigata

Options:
 .104 .108 not available with siphon cover .109 .111 .112 .136 .142 .156 .158







§1396.5 ○/●/●●●*
Countertop washbasin
 Waschtisch, unterbaufähig
 Lavabo à poser sur meuble
 Lavabo consolle

§1996.2
Pedestal, ceramic
 Säule, Keramik
 Colonne, céramique
 Colonna, ceramica

§1996.3
Siphon cover, ceramic
 Siphonverkleidung, Keramik
 Cache siphon, céramique
 Coprisifone, ceramica

§8596.0
Towel frame
 Handtuchrahmen
 Tablier pour serviette
 Portasalvietta

§1696.5 ○/●/●●●
Washbasin, undersurface ground
 Aufsatz-Waschtisch, wandmontiert
 Lavabo, face inférieure meulée
 Lavabo, superficie inferiore levigata

Options:
 .104 .108 not available with siphon cover .109 .111 .112 .136 .158

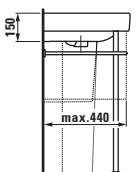
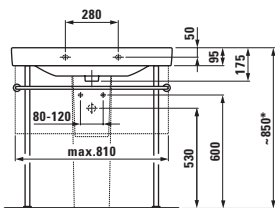
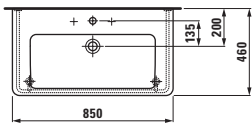

§1396.6 ○/●/●●●*
Countertop washbasin
 Waschtisch, unterbaufähig
 Lavabo à poser sur meuble
 Lavabo consolle

§1996.2
Pedestal, ceramic
 Säule, Keramik
 Colonne, céramique
 Colonna, ceramica

§1996.3
Siphon cover, ceramic
 Siphonverkleidung, Keramik
 Cache siphon, céramique
 Coprisifone, ceramica

§8596.1
Towel frame
 Handtuchrahmen
 Tablier pour serviette
 Portasalvietta

§1696.6 ○/●/●●●
Washbasin, undersurface ground
 Aufsatz-Waschtisch, wandmontiert
 Lavabo, face inférieure meulée
 Lavabo, superficie inferiore levigata

Options:
 .104 .108 not available with siphon cover .109 .111 .112 .136 .158

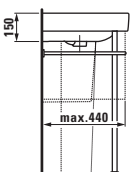
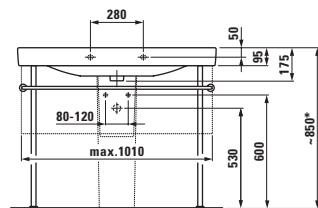
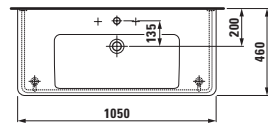

§1496.8 ○/●/●●●*
Double countertop washbasin
 Doppelwaschtisch, unterbaufähig
 Lavabo double à poser sur meuble
 Lavabo consolle doppio

§1996.2
Pedestal, ceramic
 Säule, Keramik
 Colonne, céramique
 Colonna, ceramica

§1996.3
Siphon cover, ceramic
 Siphonverkleidung, Keramik
 Cache siphon, céramique
 Coprisifone, ceramica

§8596.2
Towel frame
 Handtuchrahmen
 Tablier pour serviette
 Portasalvietta

Options:
 .104 .108 not available with siphon cover .109 .111 .112 .136 .158

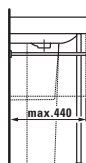
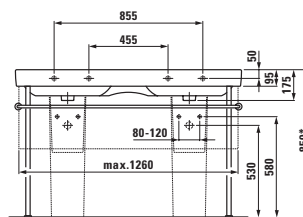
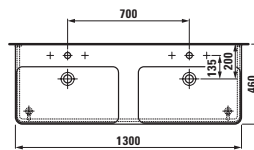

Compact countertop washbasin ○/●/●●●
 Waschtisch Compact, unterbaufähig
 Lavabo à poser sur meuble Compact
 Lavabo consolle Compact

| | A | B |
|---------|-----|-----|
| §1895.8 | 550 | 510 |
| §1895.9 | 600 | 550 |

§1995.0
Pedestal, ceramic
 Säule, Keramik
 Colonne, céramique
 Colonna, ceramica

§1995.1
Siphon cover, ceramic
 Siphonverkleidung, Keramik
 Cache siphon, céramique
 Coprisifone, ceramica

Washbasin, undersurface ground
 Aufsatz-Waschtisch, wandmontiert
 Lavabo, face inférieure meulée
 Lavabo, superficie inferiore levigata

| | A |
|---------|-----|
| §1795.8 | 550 |
| §1795.9 | 600 |

Options:
 .104 .108 not available with siphon cover .109 .142 .156

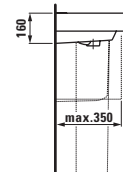
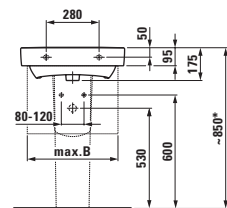
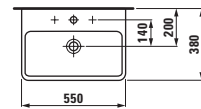

LAUFEN pro S



81896.3 ○/●/●●●
Drop-in washbasin
Einbauwaschtisch von oben
Lavabo à encastrer par-dessus
Lavabo da incasso soprapiano

Options:
 .104 .108 .109 .111 .112 .136 .158

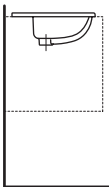
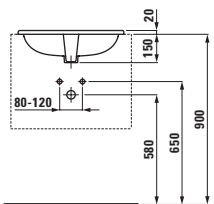
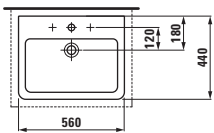

Washbasin bowl ○/●/●●●
Aufsatz-Waschtisch
Lavabo à poser
Bacinella

| | A |
|---------|-----|
| 81295.2 | 550 |
| 81295.3 | 600 |

Options:
 .104 .108 .109 .142 .156

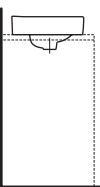
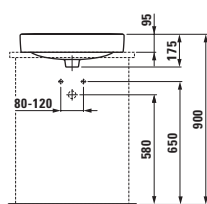
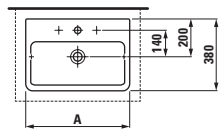

81695.2 ○
Washbasin bowl, without tapbank
Aufsatz-Waschtisch, ohne Armaturenbank
Lavabo à poser, sans plage pour la robinetterie
Bacinella, senza piano per rubinetteria

Options:
 .112

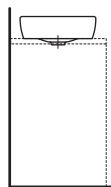
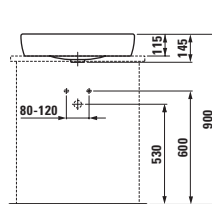
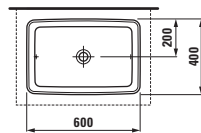

81196.6 ○/●/●●●
Built-in washbasin, with tapbank, ground
Einbauwaschtisch von unten, mit Armaturenbank, geschliffen
Lavabo à encastrer par-dessous, avec plage pour la robinetterie, meulé
Lavabo da incasso sottopiano, con piano per rubinetteria, levigato

Options:
 .104 .108 .109 .155

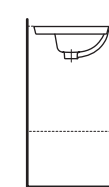
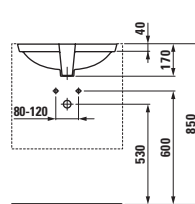
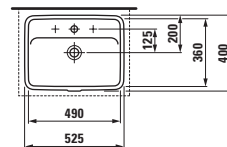



**Built-in washbasin,
without tap bank**

*Einbauwaschtisch von unten,
ohne Armaturenbank, geschliffen
Lavabo à encastrer par-dessous,
sans plage pour la robinetterie,
meulé*

*Lavabo da incasso sottopiano,
senza piano per rubinetteria, levigato*

| | A | B | C | D |
|-------------|-----|-----|-----|-----|
| §1196.0/.1* | 525 | 490 | 400 | 360 |
| §1196.3/.8* | 594 | 550 | 430 | 380 |
| §1196.5/.9* | 625 | 600 | 450 | 400 |

*** ground**

*geschliffen
meulée
levigata*

Options:

.109 .155

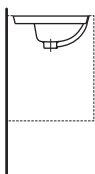
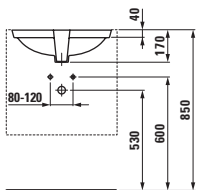
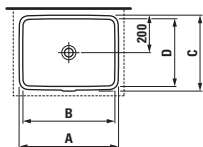

**§2096.1
Wall-hung WC, washdown**

*Wand-WC, Tiefspüler
WC suspendu, à chasse directe
Vaso sospeso, a cacciata*

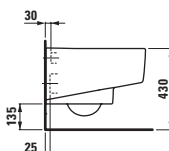
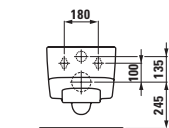
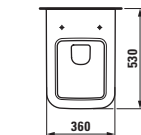

**§3096.1
Wall-hung bidet**

*Wandbidet
Bidet suspendu
Bidet sospeso*

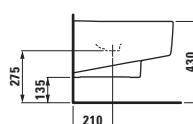
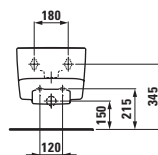
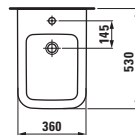

Options:

.302 .304



**§9196.0
Seat and cover, removable**

*Sitz mit Deckel, abnehmbar
Siège et couvercle, amovible
Sedile con coperchio, estraibile*

**§9196.1
Seat and cover, removable,
with lowering system**

*Sitz mit Deckel, abnehmbar,
mit Absenkautomatik
Siège et abattant, amovible,
avec système d'abaissement
Sedile con coperchio, estraibile,
con sistema a caduta rallentata*

Ceramic colours

*Keramikfarben
Couleurs céramique
Colori della ceramica*

 **.000 White**
*Weiss
Blanc
Bianco*

 **.400 White LCC**
*Weiss LCC
Blanc LCC
Bianco LCC
(Laufen Clean Coat)*

 **.757 White matt**
*Weiss matt
Blanc mat
Bianco opaco*

 **.049 Pergamon**

LAUFEN pro S



86096.1

Washbasin with vanity unit, with drawer, with space-saving siphon and soft close mechanism

Waschtisch mit Waschtischunterbau, mit Schublade, mit platzsparendem Siphon und soft close
 Lavabo avec meuble sous lavabo, avec tiroir, avec siphon compact et soft close
 Lavabo con base sottolavabo, con cassetto, con sifone compatto e soft close

86096.2

Washbasin with vanity unit, with drawer and interior drawer, with space-saving siphon and soft close mechanism

Waschtisch mit Waschtischunterbau, mit Schublade und Innenschublade, mit platzsparendem Siphon und soft close
 Lavabo avec meuble sous lavabo, avec tiroir et tiroir intérieur, avec siphon compact et soft close
 Lavabo con base sottolavabo, con cassetto e cassetto interno, con sifone compatto e soft close

Options:

.104

Furniture colours:

.423 .463 .464 .480

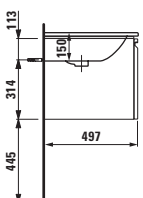
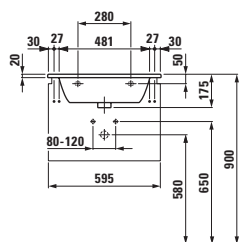
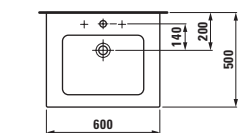

86096.3

Washbasin with vanity unit, with drawer, with space-saving siphon and soft close mechanism

Waschtisch mit Waschtischunterbau, mit Schublade, mit platzsparendem Siphon und soft close
 Lavabo avec meuble sous lavabo, avec tiroir, avec siphon compact et soft close
 Lavabo con base sottolavabo, con cassetto, con sifone compatto e soft close

86096.4

Washbasin with vanity unit, with drawer and interior drawer, with space-saving siphon and soft close mechanism

Waschtisch mit Waschtischunterbau, mit Schublade und Innenschublade, mit platzsparendem Siphon und soft close
 Lavabo avec meuble sous lavabo, avec tiroir et tiroir intérieur, avec siphon compact et soft close
 Lavabo con base sottolavabo, con cassetto e cassetto interno, con sifone compatto e soft close

Options:

.104

Furniture colours:

.423 .463 .464 .480

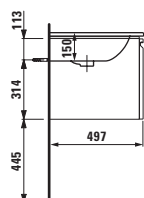
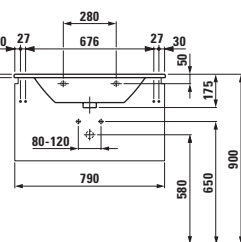
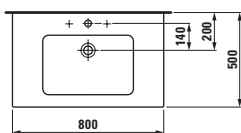

86096.5

Washbasin with vanity unit, with drawer, with space-saving siphon and soft close mechanism

Waschtisch mit Waschtischunterbau, mit Schublade, mit platzsparendem Siphon und soft close
 Lavabo avec meuble sous lavabo, avec tiroir, avec siphon compact et soft close
 Lavabo con base sottolavabo, con cassetto, con sifone compatto e soft close

86096.6

Washbasin with vanity unit, with drawer and interior drawer, with space-saving siphon and soft close mechanism

Waschtisch mit Waschtischunterbau, mit Schublade und Innenschublade, mit platzsparendem Siphon und soft close
 Lavabo avec meuble sous lavabo, avec tiroir et tiroir intérieur, avec siphon compact et soft close
 Lavabo con base sottolavabo, con cassetto e cassetto interno, con sifone compatto e soft close

Options:

.104

Furniture colours:

.423 .463 .464 .480

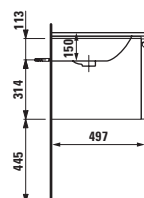
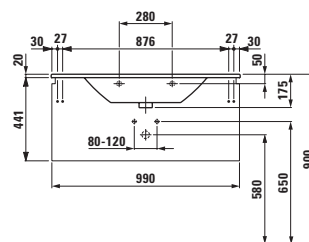
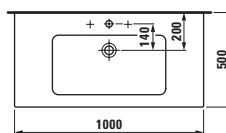

49095.2

Towel rail 400 mm, chromed metal

Handtuchhalter 400 mm, Metall verchromt
 Porte-serviettes 400 mm, en métal chromé
 Portasciugamani 400 mm, in metallo cromato

Suitable for LAUFEN pro S

Passend für LAUFEN pro S

Pour LAUFEN pro S

Adatto a LAUFEN pro S

86096.1, 86096.2, 86096.3, 86096.4,

86096.5, 86096.6





Vanity unit, with 1 internal glass shelf and 1 door, with space-saving siphon and soft close mechanism

Waschtischunterbau, mit 1 Glasfachboden innen und 1 Türe, mit platzsparendem Siphon und soft close
 Meuble sous lavabo, avec 1 étagère en verre intérieur et 1 porte, avec siphon compact et soft close
 Base sottolavabo, con 1 ripiano interno di vetro e 1 anta, con sifone compatto e soft close

48300.1 Asymmetric left, with side storage right, for washbasin 81595.5

Asymmetrisch links, mit Seitenablage rechts, für Waschtisch 81595.5
 Asymétrique gauche, avec rack latéral, pour lavabo 81595.5
 Asimmetrica sinistra, con portaoggetti laterale, per lavabo 81595.5

48300.2 Asymmetric right, with side storage right, for washbasin 81595.4

Asymmetrisch rechts, mit Seitenablage rechts, für Waschtisch 81595.4
 Asymétrique droite, avec rack latéral, pour lavabo 81595.4
 Asimmetrica destra, con portaoggetti laterale, per lavabo 81595.4

Feet, optional:
48309.1

Colours:
.423 .463 .464 .465 .480 .999

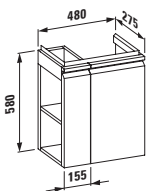
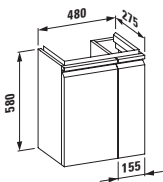

Vanity unit, with space-saving siphon and soft close mechanism, for washbasin 81596.1

Waschtischunterbau für Waschtisch, mit platzsparendem Siphon und soft close, für Waschtisch 81596.1
 Meuble sous lavabo pour lavabo, avec siphon compact et soft close, pour lavabo 81596.1
 Base sottolavabo, con sifone compatto e soft close, per lavabo 81596.1

48330.1 With door left and 1 glass shelf

Mit Tür links und 1 Glasfachboden
 Avec porte à gauche et 1 étagère en verre
 Con anta verso sinistra e 1 ripiano di vetro

48330.2 With door right and 1 glass shelf

Mit Tür rechts und 1 Glasfachboden
 Avec porte à droite et 1 étagère en verre
 Con anta verso destra e 1 ripiano di vetro

Feet, optional:
48310.0

Colours:
.423 .463 .464 .480 .999

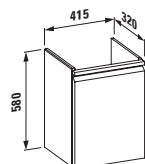

Vanity unit, with space-saving siphon and soft close mechanism, for washbasin 81895.8

Waschtischunterbau, mit platzsparendem Siphon und soft close, für Waschtisch 81895.8
 Meuble sous lavabo, avec siphon compact et soft close, pour lavabo 81895.8
 Base sottolavabo, con sifone compatto e soft close, per lavabo 81895.8

48302.1 With drawer

Mit Schublade
 Avec tiroir
 Con cassetto

48302.2 With drawer and interior drawer

Mit Schublade und Innenschublade
 Avec tiroir et tiroir intérieur
 Con cassetto e cassetto interno

Feet, optional:
48309.5

Colours:
.423 .463 .464 .465 .480 .999

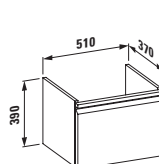

Vanity unit, with space-saving siphon and soft close mechanism, for washbasin 81096.2

Waschtischunterbau, mit platzsparendem Siphon und soft close, für Waschtisch 81096.2
 Meuble sous lavabo, avec siphon compact et soft close, pour lavabo 81096.2
 Base sottolavabo, con sifone compatto e soft close, per lavabo 81096.2

48335.1 With drawer

Mit Schublade
 Avec tiroir
 Con cassetto

48335.2 With drawer and interior drawer

Mit Schublade und Innenschublade
 Avec tiroir et tiroir intérieur
 Con cassetto e cassetto interno

Feet, optional:
48310.1

Colours:
.423 .463 .464 .480 .999

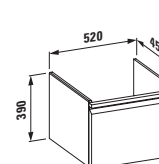

LAUFEN pro S



Vanity unit, with space-saving siphon and soft close mechanism, for washbasin 81895.9

Waschtischunterbau, mit platzsparendem Siphon und soft close, für Waschtisch 81895.9

Meuble sous lavabo, avec siphon compact et soft close, pour lavabo 81895.9

Base sottolavabo, con sifone compatto e soft close, per lavabo 81895.9

48303.1

With drawer

Mit Schublade

Avec tiroir

Con cassetto

48303.2

With drawer and interior drawer

Mit Schublade und Innenschublade

Avec tiroir et tiroir intérieur

Con cassetto e cassetto interno

Feet, optional:

48309.5

Colours:

.423 .463 .464 .465 .480 .999

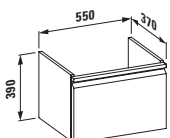

Vanity unit, with space-saving siphon and soft close mechanism, for washbasin 81096.3

Waschtischunterbau, mit platzsparendem Siphon und soft close, für Waschtisch 81096.3

Meuble sous lavabo, avec siphon compact et soft close, pour lavabo 81096.3

Base sottolavabo, con sifone compatto e soft close, per lavabo 81096.3

48337.1

With drawer

Mit Schublade

Avec tiroir

Con cassetto

48337.2

With drawer and interior drawer

Mit Schublade und Innenschublade

Avec tiroir et tiroir intérieur

Con cassetto e cassetto interno

Feet, optional:

48310.1

Colours:

.423 .463 .464 .480 .999

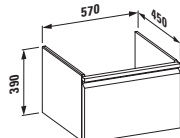

Vanity unit, with space-saving siphon and soft close mechanism, for washbasin 81096.4

Waschtischunterbau, mit platzsparendem Siphon und soft close, für Waschtisch 81096.4

Meuble sous lavabo, avec siphon compact et soft close, pour lavabo 81096.4

Base sottolavabo, con sifone compatto e soft close, per lavabo 81096.4

48342.1

With drawer

Mit Schublade

Avec tiroir

Con cassetto

48342.2

With drawer and interior drawer

Mit Schublade und Innenschublade

Avec tiroir et tiroir intérieur

Con cassetto e cassetto interno

Feet, optional:

48310.1

Colours:

.423 .463 .464 .480 .999

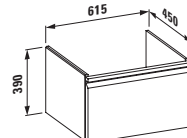

Vanity unit, with space-saving siphon and soft close mechanism, for washbasin 81096.7

Waschtischunterbau, mit platzsparendem Siphon und soft close, für Waschtisch 81096.7

Meuble sous lavabo, avec siphon compact et soft close, pour lavabo 81096.7

Base sottolavabo, con sifone compatto e soft close, per lavabo 81096.7

48345.1

With drawer

Mit Schublade

Avec tiroir

Con cassetto

48345.2

With drawer and interior drawer

Mit Schublade und Innenschublade

Avec tiroir et tiroir intérieur

Con cassetto e cassetto interno

Feet, optional:

48310.1

Colours:

.423 .463 .464 .480 .999

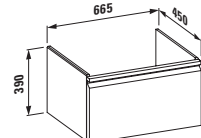



Vanity unit, with space-saving siphon and soft close mechanism, for washbasin 81396.5

Waschtischunterbau, mit platzsparendem Siphon und soft close, für Waschtisch 81396.5

Meuble sous lavabo, avec siphon compact et soft close, pour lavabo 81396.5

Base sottolavabo, con sifone compatto e soft close, per lavabo 81396.5

48350.1

With drawer

Mit Schublade

Avec tiroir

Con cassetto

48350.2

With drawer and interior drawer

Mit Schublade und Innenschublade

Avec tiroir et tiroir intérieur

Con cassetto e cassetto interno

Feet, optional:

48310.1

Colours:

.423 .463 .464 .480 .999

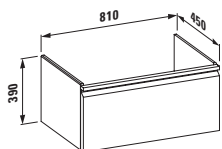

Vanity unit, with space-saving siphon and soft close mechanism, for washbasin 81396.6

Waschtischunterbau, mit platzsparendem Siphon und soft close, für Waschtisch 81396.6

Meuble sous lavabo, avec siphon compact et soft close, pour lavabo 81396.6

Base sottolavabo, con sifone compatto e soft close, per lavabo 81396.6

48355.1

With drawer

Mit Schublade

Avec tiroir

Con cassetto

48355.2

With drawer and interior drawer

Mit Schublade und Innenschublade

Avec tiroir et tiroir intérieur

Con cassetto e cassetto interno

Feet, optional:

48310.1

Colours:

.423 .463 .464 .480 .999

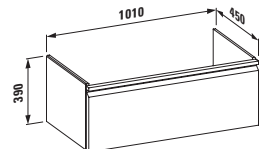

Vanity unit, with space-saving siphon and soft close mechanism, for washbasin 81496.8

Waschtischunterbau, mit platzsparendem Siphon und soft close, für Waschtisch 81496.8

Meuble sous lavabo, avec siphon compact et soft close, pour lavabo 81496.8

Base sottolavabo, con sifone compatto e soft close, per lavabo 81496.8

48357.1

With 2 drawers

Mit 2 Schubladen

Avec 2 tiroirs

Con 2 cassette

48357.2

With 2 drawers and interior drawer

Mit 2 Schubladen und Innenschublade

Avec 2 tiroirs et tiroir intérieur

Con 2 cassette e cassetto interno

Feet, optional:

48310.1

Colours:

.423 .463 .464 .465 .480 .999

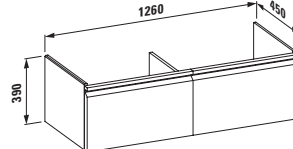

LAUFEN pro S



Medium cabinet, with 2 glass shelves, with soft close mechanism

Halbhochschrank, mit 2 Glasfachböden, mit soft close
Armoire mi-haute, avec 2 étagères en verre, avec soft close
Colonna media, con 2 ripiani di vetro, con soft close

48311.1

Door hinges left

Türanschlag links
Charnières de porte à gauche
Anta con apertura verso sinistra

48311.2

Door hinges right

Türanschlag rechts
Charnières de porte à droite

Colours:

.423 .463 .464 .480 .999

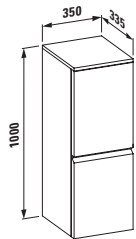

Tall cabinet, with 2 glass shelves, with soft close mechanism

Hochschrank, mit 2 Glasfachböden, mit soft close
Armoire, avec 2 étagères en verre, avec soft close
Colonna, con 2 ripiani di vetro, con soft close

48312.1

Door hinges left

Türanschlag links
Charnières de porte à gauche
Anta con apertura verso sinistra

48312.2

Door hinges right

Türanschlag rechts
Charnières de porte à droite
Anta con apertura verso destra

Colours:

.423 .463 .464 .480 .999

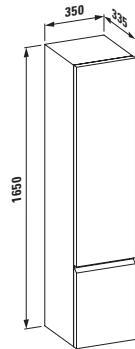

Small cabinet, with soft close mechanism

Kleiner Hochschrank, mit soft close
Petite armoire, avec soft close
Colonna piccola, con soft close

48311.3

Door hinges left

Türanschlag links
Charnières de porte à gauche
Anta con apertura verso sinistra

48311.4

Door hinges right

Türanschlag rechts
Charnières de porte à droite
Anta con apertura verso destra

Colours:

.423 .463 .464 .480 .999

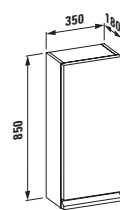

49095.0

Towel rail 270 mm, chromed metal

Handtuchhalter 270 mm, Metall verchromt
Porte-serviettes 270 mm, en métal chromé
Portasciugamani 270 mm, in metallo cromato

Suitable for LAUFEN pro S

Passend für LAUFEN pro S
Pour LAUFEN pro S
Adatto a LAUFEN pro S
 48302.1, 48302.2, 48303.1, 48303.2



49095.2

Towel rail 400 mm, chromed metal

Handtuchhalter 400 mm, Metall verchromt
Porte-serviettes 400 mm, en métal chromé
Portasciugamani 400 mm, in metallo cromato

Suitable for LAUFEN pro S

Passend für LAUFEN pro S
Pour LAUFEN pro S
Adatto a LAUFEN pro S
 48335.1, 48335.2, 48337.1, 48337.2, 48342.1, 48342.2, 48345.1, 48345.2, 48350.1, 48350.2, 48355.1, 48355.2, 48357.1, 48357.2, 48357.1, 48357.2



Colours of furniture

Möbelfarben
Couleurs des meubles
Colori dei mobili



.463 White matt
Weiss matt
Blanc mat
Bianco opaco



.464 White glossy
Weiss glänzend
Blanc brillant
Bianco brillante



.423 Wenge
Wenge
Wengé



.480 Graphite
Graphit
Graphite
Grafite

.999 Multicolor

Please state colour number in the order text.

Bitte Farbnummer in der Bestellung angeben.

Prière de préciser le numéro de la couleur dans le texte de la commande.

Si prega di specificare il numero di colore nell'ordine.

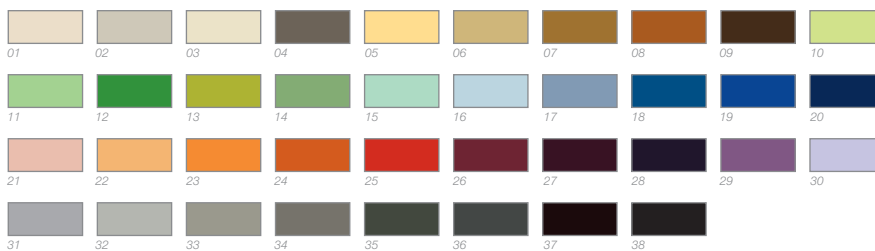

LAUFEN pro B



81695.7 ○/●
Small washbasin, tap hole left or right
Handwaschbecken, Hahnloch links oder rechts
Lave-mains, trou pour la robinetterie à gauche ou à droite
Lavamani, foro per rubinetteria a sinistra o a destra



○/●
Small washbasin
Handwaschbecken
Lave-mains
Lavamani

| | A | B |
|---------|-----|-----|
| 81595.0 | 350 | 310 |
| 81595.1 | 400 | 320 |



○/●
Small washbasin
Handwaschbecken
Lave-mains
Lavamani

| | A | B |
|---------|-----|-----|
| 81595.2 | 450 | 330 |
| 81595.3 | 500 | 360 |



○/●/●●●
Washbasin
Waschtisch
Lavabo
Lavabo

| | A | B | C | D |
|---------|-----|-----|-----|-----|
| 81095.1 | 550 | 440 | 160 | 185 |
| 81095.2 | 600 | 480 | 165 | 190 |
| 81095.3 | 650 | 500 | 175 | 195 |

Options:
 .105 .106 .109

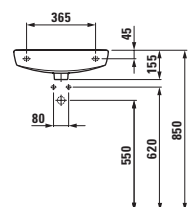
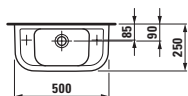

Options:
 .104 .109

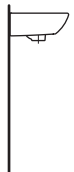
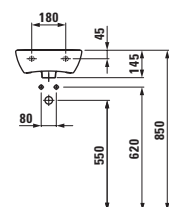
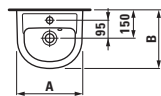

Options:
 .104 .109 .142 .156

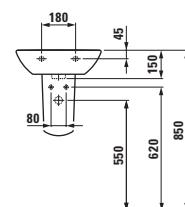
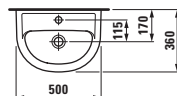

Options:
 .104 .108 .109 .142 .156

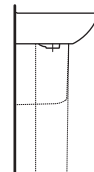
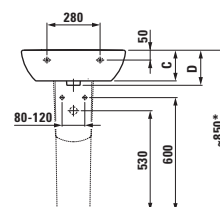
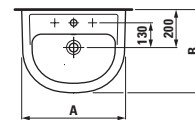

LAUFEN pro B



Compact washbasin ○/●/●●●
 Waschtisch Compact
 Lavabo Compact
 Lavabo Compact

| | A | B |
|---------|-----|-----|
| 81495.1 | 550 | 400 |
| 81495.2 | 600 | 420 |

81995.0
Pedestal, ceramic
 Säule, Keramik
 Colonne, céramique
 Colonna, ceramica

81995.1
Siphon cover, ceramic
 Siphonverkleidung, Keramik
 Cache siphon, céramique
 Coprisifone, ceramica

Options:
 .104 .108 .109 .142 .156

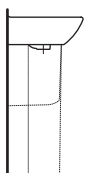
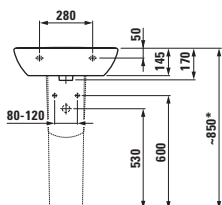
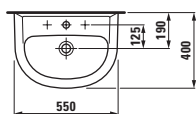

81695.8 ○/●
Corner small washbasin
 Eck-Handwaschbecken
 Lave-mains d'angle
 Lavamani d'angolo

Options:
 .104 .109

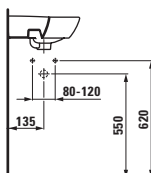
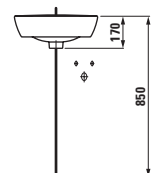
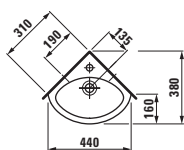

81695.6 ○/●
Corner small washbasin
 Eck-Handwaschbecken
 Lave-mains d'angle
 Lavamani d'angolo

Options:
 .104 .109

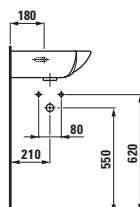
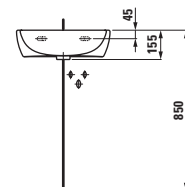
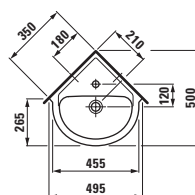

81295.1 ○/●
Semi-recessed washbasin
 Halbeinbauwaschtisch
 Lavabo à semi-encastrer
 Lavabo semincasso

Options:
 .104 .109

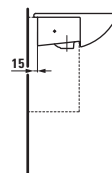
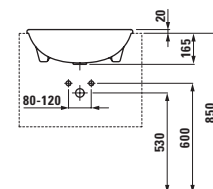
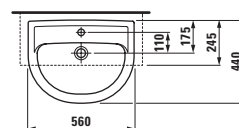



81395.1 **Drop-in washbasin** ○/●
 Einbauwaschtisch von oben
 Lavabo à encastrer par-dessus
 Lavabo da incasso soprapiano

Options:
 .104 .109

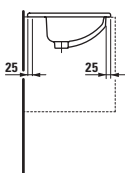
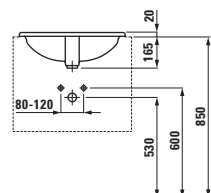
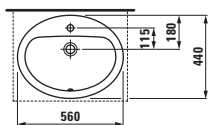

81296.2 **Washbasin bowl** ○
 Aufsatz-Waschtisch
 Lavabo à poser
 Bacinella

Options:
 .109 .112 .142

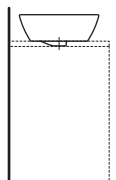
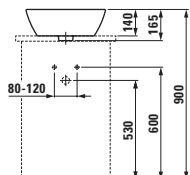
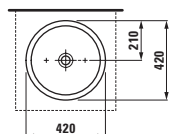

81296.4 **Washbasin bowl** ○
 Aufsatz-Waschtisch
 Lavabo à poser
 Bacinella

Options:
 .109 .112 .142

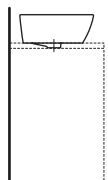
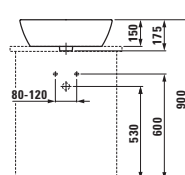
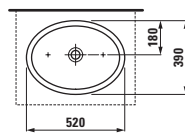

81896.1 **Built-in washbasin, without tapbank** ○
 Einbauwaschtisch von unten, ohne Armaturenbank
 Lavabo à encastrer par-dessous, sans plage pour la robinetterie
 Lavabo da incasso sottopiano, senza piano per rubinetteria

81896.2 **Built-in washbasin, without tapbank, ground**
 Einbauwaschtisch von unten, ohne Armaturenbank, geschliffen
 Lavabo à encastrer par-dessous, sans plage pour la robinetterie, meulé
 Lavabo da incasso sottopiano, senza piano per rubinetteria, levigato

Options:
 .109 .155

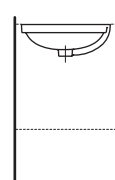
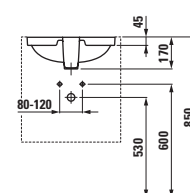
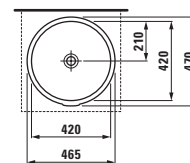

LAUFEN pro B



48303.5

Vanity unit, with one drawer and one glass shelf, with facing, with space-saving siphon and soft close mechanism, for washbasin
81095.1, 81095.2, 81095.3

Waschtischunterbau, mit einer Schublade und einem Glasfachboden, mit Blende, mit platzsparendem Siphon und soft close, passend zu Waschtischen 81095.1, 81095.2, 81095.3
 Meuble sous lavabo, avec un tiroir et une étagère en verre, avec habillage, avec siphon compact et soft close, pour lavabos 81095.1, 81095.2, 81095.3
 Base sottolavabo, con un cassetto e un ripiano di vetro, con collarino, con sifone salvaspazio e soft close, per lavabi 81095.1, 81095.2, 81095.3

Colours:

.423 .463 .464 .465 .999

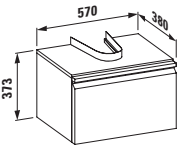

Medium cabinet, with 2 glass shelves, with soft close mechanism

Halbhochschrank, mit 2 Glasfachböden, mit soft close
 Armoire mi-haute, avec 2 étagères en verre, avec soft close
 Colonna media, con 2 ripiani di vetro, con soft close

48311.1

Door hinges left

Türanschlag links
 Charnières de porte à gauche
 Anta con apertura verso sinistra

48311.2

Door hinges right

Türanschlag rechts
 Charnières de porte à droite
 Anta con apertura verso destra

Colours:

.423 .463 .464 .465 .999

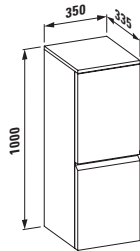

Tall cabinet, with 2 glass shelves, with soft close mechanism

Hochschrank, mit 2 Glasfachböden, mit soft close
 Armoire, avec 2 étagères en verre, avec soft close
 Colonna, con 2 ripiani di vetro, con soft close

48312.1

Door hinges left

Türanschlag links
 Charnières de porte à gauche
 Anta con apertura verso sinistra

48312.2

Door hinges right

Türanschlag rechts
 Charnières de porte à droite
 Anta con apertura verso destra

Colours:

.423 .463 .464 .465 .999

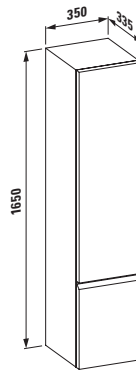

49095.1

Towel rail 400 mm, chromed metal

Handtuchhalter 400 mm, Metall verchromt
 Porte-serviettes 400 mm, en métal chromé
 Portasciugamani 400 mm, in metallo cromato

Suitable for LAUFEN pro B

Passend für LAUFEN pro B
 Pour LAUFEN pro B
 Adatto a LAUFEN pro B
48303.5



Colours of furniture, decor

Möbelfarben, Dekor
 Couleurs des meubles, décor
 Colori dei mobili, finitura

.999 Multicolor

Please state colour number in the order text.

Bitte Farbnummer in der Bestellung angeben.

Prière de préciser le numéro de la couleur dans le texte de la commande.

Si prega di specificare il numero di colore nell'ordine.

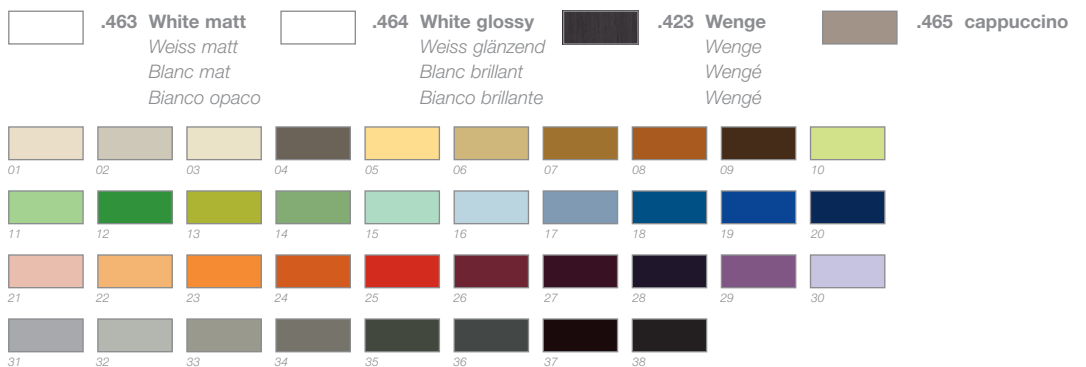



81695.5
Small washbasin
 Handwaschbecken
 Lave-mains
 Lavamani



Options:
 .106 .109

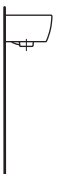
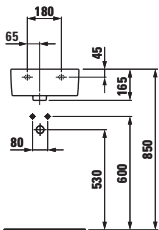
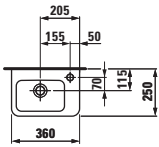

81195.1
Small countertop washbasin
 Handwaschbecken, unterbaufähig
 Lave-mains à poser sur meuble
 Lavamani consolle



81995.2
Siphon cover, ceramic
 Siphonverkleidung, Keramik
 Cache-siphon, céramique
 Coprisifone in ceramica

81195.2
Washbasin, undersurface ground
 Aufsatz-Waschtisch, wandmontiert
 Lavabo, face inférieur meulée
 Lavabo, superficie inferiore levigata

Options:
 .104 .109 .142 .156

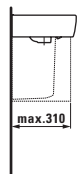
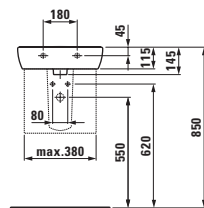
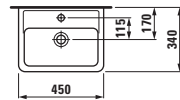

Washbasin
 Waschtisch
 Lavabo
 Lavabo



| | A | B | C |
|---------|-----|-----|-----|
| 81895.1 | 550 | 135 | 470 |
| 81895.2 | 600 | 135 | 520 |
| 81895.3 | 650 | 130 | 570 |

81995.0
Pedestal, ceramic
 Säule, Keramik
 Colonne, céramique
 Colonna, ceramica

81995.1
Siphon cover, ceramic
 Siphonverkleidung, Keramik
 Cache siphon, céramique
 Coprisifone, ceramica

Washbasin, undersurface ground
 Aufsatz-Waschtisch, wandmontiert
 Lavabo, face inférieur meulée
 Lavabo, superficie inferiore levigata



| | A | B |
|---------|-----|-----|
| 81795.1 | 550 | 135 |
| 81795.2 | 600 | 135 |
| 81795.3 | 650 | 130 |

Options:
 .104 .108* .109 .142 .156

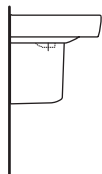
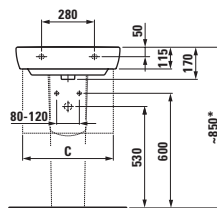
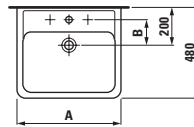

81395.6
Countertop washbasin
 Waschtisch unterbaufähig
 Lavabo à poser sur meuble
 Lavabo consolle



81995.0
Pedestal, ceramic
 Säule, Keramik
 Colonne, céramique
 Colonna, ceramica

81995.1
Siphon cover, ceramic
 Siphonverkleidung, Keramik
 Cache siphon, céramique
 Coprisifone, ceramica

81295.6
Washbasin, undersurface ground
 Aufsatz-Waschtisch, wandmontiert
 Lavabo, face inférieur meulée
 Lavabo, superficie inferiore levigata



89095.6.004.000.1
Towel frame
 Handtuchrahmen
 Tablier pour serviette
 Portaserviette

Options:
 .104 .108* .109 .142 .156

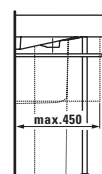
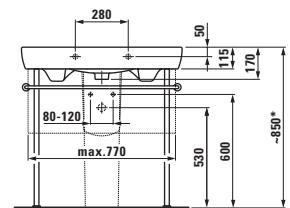
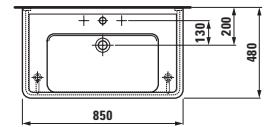

LAUFEN pro A



81395.8 ○/●/●●●*

Countertop washbasin
Waschtisch unterbaufähig
Lavabo à poser sur meuble
Lavabo consolle

81995.0
Pedestal, ceramic
Säule, Keramik
Colonne, céramique
Colonna, ceramica

81995.1
Siphon cover, ceramic
Siphonverkleidung, Keramik
Cache siphon, céramique
Coprisifone, ceramica

81295.8 ○/●/●●●
Washbasin, undersurface ground
Aufsatz-Waschtisch, wandmontiert
Lavabo, face inférieure meulée
Lavabo, superficie inferiore levigata

89095.8.004.000.1
Towel frame
Handtuchrahmen
Tablier pour serviette
Portasalvietta

Options:
.104 .108* .109 .142 .156

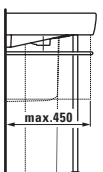
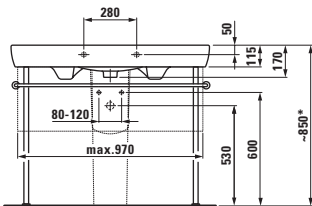
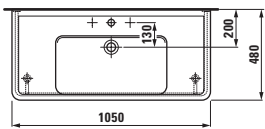

81496.7 ○/●/●●●*

Double countertop washbasin
Doppelwaschtisch unterbaufähig
Lavabo double à poser sur meuble
Lavabo consolle, doppio bacino

81995.0
Pedestal, ceramic
Säule, Keramik
Colonne, céramique
Colonna, ceramica

81995.1
Siphon cover, ceramic
Siphonverkleidung, Keramik
Cache siphon, céramique
Coprisifone, ceramica

81396.7 ○/●/●●●
Double washbasin, undersurface ground
Aufsatz-Doppelwaschtisch, wandmontiert
Lavabo, face inférieure meulée
Lavabo, superficie inferiore levigata

Options:
.104 .108* .109 .142 .156

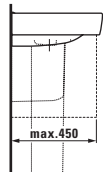
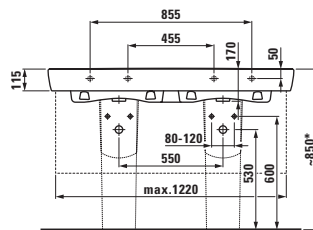
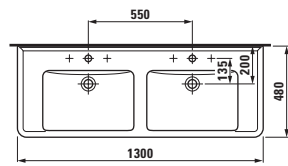

81296.1 ○/●/●●●

Semi-recessed washbasin
Halbeinbauwaschtisch
Lavabo à semi-encastrer
Lavabo semincasso

Options:
.104 .108 .109

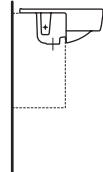
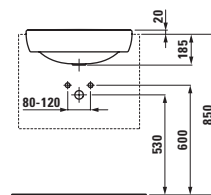
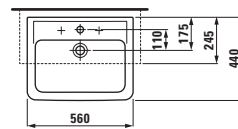

81396.1 ○/●/●●●

Drop-in washbasin
Einbauwaschtisch von oben
Lavabo à encastrer par-dessus
Lavabo da incasso soprapiano

Options:
.104 .108 .109 .155

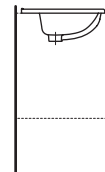
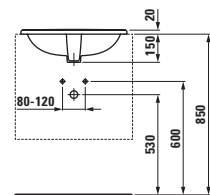
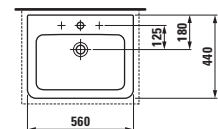



Vanity unit, with 1 glass shelf, with space-saving siphon and soft close mechanism, for washbasin 81195.1

Waschtischunterbau, mit 1 Glasfachboden, mit platzsparendem Siphon und soft close, passend zu Waschtisch 81195.1

Meuble sous lavabo, avec 1 étagère en verre, avec siphon compact et soft close, pour lavabo 81195.1
Base sottolavabo, con 1 ripiano di vetro, con sifone compatto e soft close, per lavabo 81195.1

48301.1

Door hinge left

Türanschlag links

Charnières de porte à gauche

Anta con apertura verso sinistra

48301.2

Door hinge right

Türanschlag rechts

Charnières de porte à droite

Anta con apertura verso destra

Feet, optional:

48309.1

Colours:

.423 .463 .464 .465 .999

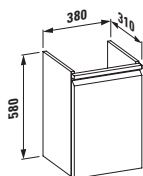

Vanity unit, with space-saving siphon and soft close mechanism, for washbasin 81895.1

Waschtischunterbau, mit platzsparendem Siphon und soft close, passend zu Waschtisch 81895.1

Meuble sous lavabo, avec siphon compact et soft close, pour lavabo 81895.1

Base sottolavabo, con sifone compatto e soft close, per lavabo 81895.1

48302.3

With drawer

Mit Schublade

Avec tiroir

Con cassetto

48302.4

With drawer and interior drawer

Mit Schublade und Innenschublade

Avec tiroir et tiroir intérieur

Con cassetto e cassetto interno

Feet, optional:

48309.2

Colours:

.423 .463 .464 .465 .999

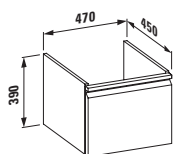

Vanity unit, with space-saving siphon and soft close mechanism, for washbasin 81895.2

Waschtischunterbau, mit platzsparendem Siphon und soft close, passend zu Waschtisch 81895.2

Meuble sous lavabo, avec siphon compact et soft close, pour lavabo 81895.2

Base sottolavabo, con sifone compatto e soft close, per lavabo 81895.2

48303.3

With drawer

Mit Schublade

Avec tiroir

Con cassetto

48303.4

With drawer and interior drawer

Mit Schublade und Innenschublade

Avec tiroir et tiroir intérieur

Con cassetto e cassetto interno

Feet, optional:

48309.2

Colours:

.423 .463 .464 .465 .999

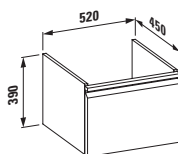

Vanity unit, with space-saving siphon and soft close mechanism, for washbasin 81895.3

Waschtischunterbau, mit platzsparendem Siphon und soft close, passend zu Waschtisch 81895.3

Meuble sous lavabo, avec siphon compact et soft close, pour lavabo 81895.3

Base sottolavabo, con sifone compatto e soft close, per lavabo 81895.3

48304.1

With drawer

Mit Schublade

Avec tiroir

Con cassetto

48304.2

With drawer and interior drawer

Mit Schublade und Innenschublade

Avec tiroir et tiroir intérieur

Con cassetto e cassetto interno

Feet, optional:

48309.2

Colours:

.423 .463 .464 .465 .999

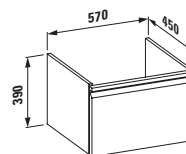

LAUFEN pro A



Vanity unit, with space-saving siphon and soft close mechanism, for washbasin 81395.6

*Waschtischunterbau, mit platzsparendem Siphon und soft close, passend zu Waschtisch 81395.6
Meuble sous lavabo, avec siphon compact et soft close, pour lavabo 81395.6*

Base sottolavabo, con sifone compatto e soft close, per lavabo 81395.6

48306.1

With 1 drawer

*Mit 1 Schublade
Avec 1 tiroir
Con 1 cassetto*

48306.2

With 1 drawer and interior drawer

*Mit 1 Schublade und Innenschublade
Avec 1 tiroir et tiroir intérieur
Con 1 cassetto e cassetto interno*

Feet, optional:
48309.2

Colours:

.423 .463 .464 .465 .999

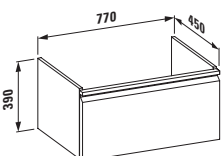

Vanity unit, with space-saving siphon and soft close mechanism, for washbasin 81395.8

*Waschtischunterbau, mit platzsparendem Siphon und soft close, passend zu Waschtisch 81395.8
Meuble sous lavabo, avec siphon compact et soft close, pour lavabo 81395.8*

Base sottolavabo, con sifone compatto e soft close, per lavabo 81395.8

48307.1

With 1 drawer

*Mit 1 Schublade
Avec 1 tiroir
Con 1 cassetto*

48307.2

With 1 drawer and interior drawer

*Mit 1 Schublade und Innenschublade
Avec 1 tiroir et tiroir intérieur
Con 1 cassetto e cassetto interno*

Feet, optional:
48309.2

Colours:

.423 .463 .464 .465 .999

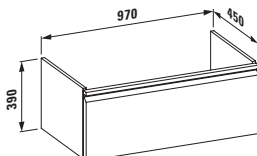

Vanity unit, with space-saving siphon and soft close mechanism, for washbasin 81496.7

*Waschtischunterbau, mit platzsparendem Siphon und soft close, passend zu Waschtisch 81496.7
Meuble sous lavabo, avec siphon compact et soft close, pour lavabo 81496.7*

Base sottolavabo, con sifone compatto e soft close, per lavabo 81496.7

48308.1

With 2 drawers

*Mit 2 Schubladen
Avec 2 tiroirs
Con 2 cassetti*

48308.2

With 2 drawers and 2 interior drawers

*Mit 2 Schubladen und 2 Innenschubladen
Avec 2 tiroirs et 2 tiroirs intérieurs
Con 2 cassetti e 2 cassetti interni*

Feet, optional:
48309.2

Colours:

.423 .463 .464 .465 .999

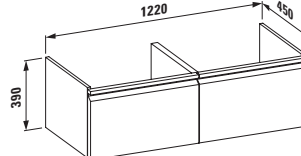

LAUFEN pro A



Medium cabinet, with 2 glass shelves, with soft close mechanism

Halbhochschrank, mit 2 Glasfachböden, mit soft close
Armoire mi-haute, avec 2 étagères en verre, avec soft close
Colonna media, con 2 ripiani di vetro, con soft close

48311.1

Door hinges left

Türanschlag links
Charnières de porte à gauche
Anta con apertura verso sinistra

48311.2

Door hinges right

Türanschlag rechts
Charnières de porte à droite
Anta con apertura verso destra

Colours:

.423 .463 .464 .465 .999

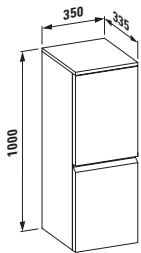

Tall cabinet, with 2 glass shelves, with soft close mechanism

Hochschrank, mit 2 Glasfachböden, mit soft close
Armoire, avec 2 étagères en verre, avec soft close
Colonna, con 2 ripiani di vetro, con soft close

48312.1

Door hinges left

Türanschlag links
Charnières de porte à gauche
Anta con apertura verso sinistra

48312.2

Door hinges right

Türanschlag rechts
Charnières de porte à droite
Anta con apertura verso destra

Colours:

.423 .463 .464 .465 .999

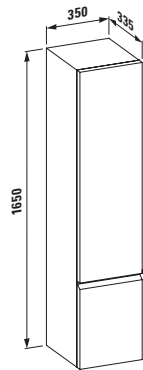

Small cabinet, with soft close mechanism

Kleiner Hochschrank, mit soft close
Petite armoire, avec soft close
Colonna piccola, con soft close

48311.3

Door hinges left

Türanschlag links
Charnières de porte à gauche
Anta con apertura verso sinistra

48311.4

Door hinges right

Türanschlag rechts
Charnières de porte à droite
Anta con apertura verso destra

Colours:

.423 .463 .464 .465 .999

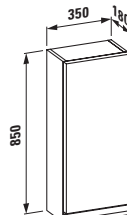

49095.2

Towel rail 400 mm, chromed metal

Handtuchhalter 400 mm, Metall verchromt
Porte-serviettes 400 mm, en métal chromé
Portasciugamani 400 mm, in metallo cromato

Suitable for LAUFEN pro A

Passend für LAUFEN pro A
Pour LAUFEN pro A
Adatto a LAUFEN pro A
 48302.3, 48302.4, 48303.3, 48303.4,
 48304.1, 48304.2, 48306.1, 48306.2,
 48307.1, 48307.2, 48308.1, 48308.2



Colours of furniture, decor

Möbelfarben, Dekor
Couleurs des meubles, décor
Colori dei mobili, finitura

| | | | | | | | |
|--|--|--|---|--|---|--|------------------------|
| | .463 White matt <i>Weiss matt</i> <i>Blanc mat</i> <i>Bianco opaco</i> | | .464 White glossy <i>Weiss glänzend</i> <i>Blanc brillant</i> <i>Bianco brillante</i> | | .423 Wenge <i>Wenge</i> <i>Wengé</i> <i>Wengé</i> | | .465 cappuccino |
|--|--|--|---|--|---|--|------------------------|

.999 Multicolor

Please state colour number in the order text.

Bitte Farbnummer in der Bestellung angeben.

Prière de préciser le numéro de la couleur dans le texte de la commande.

Si prega di specificare il numero di colore nell'ordine.

| | | | | | | | | | |
|----|----|----|----|----|----|----|----|----|----|
| | | | | | | | | | |
| 01 | 02 | 03 | 04 | 05 | 06 | 07 | 08 | 09 | 10 |
| | | | | | | | | | |
| 11 | 12 | 13 | 14 | 15 | 16 | 17 | 18 | 19 | 20 |
| | | | | | | | | | |
| 21 | 22 | 23 | 24 | 25 | 26 | 27 | 28 | 29 | 30 |
| | | | | | | | | | |
| 31 | 32 | 33 | 34 | 35 | 36 | 37 | 38 | | |



82095.6

Wall-hung WC, washdown

Wand-WC, Tiefspüler

WC suspendu, à chasse directe

Vaso sospeso, a cacciata

4,5L 8L

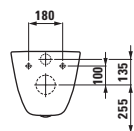
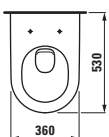

82096.6

Wall-hung WC rimless, washdown

Wand-WC rimless, Tiefspüler

WC suspendu rimless, à chasse directe

Vaso sospeso rimless, a cacciata

4,5L 8L

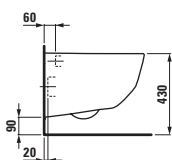
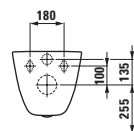
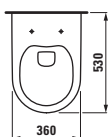

82096.5

Compact wall-hung WC rimless, washdown

Wand-WC Compact rimless, Tiefspüler

WC suspendu Compact rimless, à chasse directe

Vaso sospeso Compact rimless, a cacciata

4,5L 8L

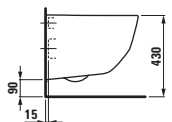
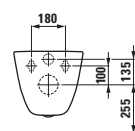
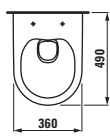

83095.2.302

Wall-hung bidet, 1 tap hole in centre, without lateral holes for water inlet

Wand-Bidet, 1 Hahnloch mittig, ohne seitliche Löcher für Wasseranschluss

Bidet suspendu, avec 1 trou pour la robinetterie au milieu, sans trous latéraux pour le raccordement de l'eau

Bidet sospeso, 1 foro centrale per la rubinetteria, senza fori laterali per l'alimentazione dell'acqua

Bidet sospeso, 1 foro centrale per la rubinetteria, senza fori laterali per l'alimentazione dell'acqua

Bidet sospeso, 1 foro centrale per la rubinetteria, senza fori laterali per l'alimentazione dell'acqua

Bidet sospeso, 1 foro centrale per la rubinetteria, senza fori laterali per l'alimentazione dell'acqua

Bidet sospeso, 1 foro centrale per la rubinetteria, senza fori laterali per l'alimentazione dell'acqua

Bidet sospeso, 1 foro centrale per la rubinetteria, senza fori laterali per l'alimentazione dell'acqua

Bidet sospeso, 1 foro centrale per la rubinetteria, senza fori laterali per l'alimentazione dell'acqua

Bidet sospeso, 1 foro centrale per la rubinetteria, senza fori laterali per l'alimentazione dell'acqua

Bidet sospeso, 1 foro centrale per la rubinetteria, senza fori laterali per l'alimentazione dell'acqua

Bidet sospeso, 1 foro centrale per la rubinetteria, senza fori laterali per l'alimentazione dell'acqua

Bidet sospeso, 1 foro centrale per la rubinetteria, senza fori laterali per l'alimentazione dell'acqua

Bidet sospeso, 1 foro centrale per la rubinetteria, senza fori laterali per l'alimentazione dell'acqua

Bidet sospeso, 1 foro centrale per la rubinetteria, senza fori laterali per l'alimentazione dell'acqua

Bidet sospeso, 1 foro centrale per la rubinetteria, senza fori laterali per l'alimentazione dell'acqua

Bidet sospeso, 1 foro centrale per la rubinetteria, senza fori laterali per l'alimentazione dell'acqua

Bidet sospeso, 1 foro centrale per la rubinetteria, senza fori laterali per l'alimentazione dell'acqua

Bidet sospeso, 1 foro centrale per la rubinetteria, senza fori laterali per l'alimentazione dell'acqua

Bidet sospeso, 1 foro centrale per la rubinetteria, senza fori laterali per l'alimentazione dell'acqua

Bidet sospeso, 1 foro centrale per la rubinetteria, senza fori laterali per l'alimentazione dell'acqua

Bidet sospeso, 1 foro centrale per la rubinetteria, senza fori laterali per l'alimentazione dell'acqua

Bidet sospeso, 1 foro centrale per la rubinetteria, senza fori laterali per l'alimentazione dell'acqua

Bidet sospeso, 1 foro centrale per la rubinetteria, senza fori laterali per l'alimentazione dell'acqua

Bidet sospeso, 1 foro centrale per la rubinetteria, senza fori laterali per l'alimentazione dell'acqua

Bidet sospeso, 1 foro centrale per la rubinetteria, senza fori laterali per l'alimentazione dell'acqua

Bidet sospeso, 1 foro centrale per la rubinetteria, senza fori laterali per l'alimentazione dell'acqua

Bidet sospeso, 1 foro centrale per la rubinetteria, senza fori laterali per l'alimentazione dell'acqua

Bidet sospeso, 1 foro centrale per la rubinetteria, senza fori laterali per l'alimentazione dell'acqua

Bidet sospeso, 1 foro centrale per la rubinetteria, senza fori laterali per l'alimentazione dell'acqua

Bidet sospeso, 1 foro centrale per la rubinetteria, senza fori laterali per l'alimentazione dell'acqua

Bidet sospeso, 1 foro centrale per la rubinetteria, senza fori laterali per l'alimentazione dell'acqua

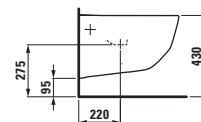
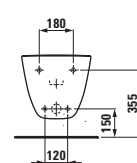
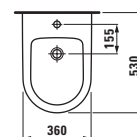



§2595.2
Floorstanding WC combination, washdown, outlet Vario, back-to-wall

Stand-WC-Kombination, Tiefspüler, Abgang Vario, wandbündig
Installation de WC au sol, à chasse directe, évacuation Vario, dos au mur
Vaso monoblocco a pavimento, a cacciata, scarico Vario, a filo muro

§2595.2.231

Floorstanding WC combination, washdown, outlet Vario, back-to-wall, with lateral holes for water inlet

Stand-WC-Kombination, Tiefspüler, Abgang Vario, wandbündig, mit seitlichen Löchern für Wasseranschluss
Installation de WC au sol, à chasse directe, évacuation Vario, dos au mur, avec trous latéraux pour le raccordement de l'eau
Vaso monoblocco a pavimento, a cacciata, scarico Vario, a filo muro, senza fori laterali per l'alimentazione dell'acqua

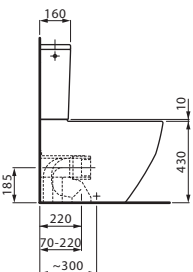
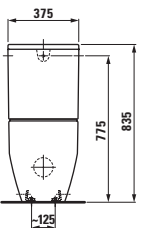
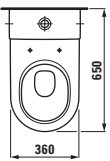

Only for WC

Nur für WC
Seulement pour WC
Soltanto per vaso
§2595.2

§2995.1

Cistern, Dual Flush, water connection at back

Spülkasten, Dual Flush, Wasseranschluss hinten
Réservoir, Dual Flush, raccordement de l'eau à l'arrière
Cassetta di risciacquo, Dual Flush, alimentazione dell'acqua posteriore

§2995.2

Cistern, Dual Flush, water connection on one side (left or right)

Spülkasten, Dual Flush, Wasseranschluss seitlich (links oder rechts)
Réservoir, Dual Flush, raccordement de l'eau latéral (gauche ou droite)
Cassetta di risciacquo, Dual Flush, alimentazione dell'acqua laterale (a sinistra o a destra)

§2995.3

Cistern, Dual Flush, water connection bottom left

Spülkasten, Dual Flush, Wasseranschluss unten links
Réservoir, Dual Flush, raccordement de l'eau inférieure gauche
Cassetta di risciacquo, Dual Flush, alimentazione dell'acqua dal basso a sinistra

§2995.5

Cistern, Dual Flush, water connection bottom right

Spülkasten, Dual Flush, Wasseranschluss unten rechts
Réservoir, Dual Flush, raccordement de l'eau inférieure droite
Cassetta di risciacquo, Dual Flush, alimentazione dell'acqua dal basso a destra



§2295.2
Floorstanding WC, washdown, Vario outlet, back-to-wall

Stand-WC, Tiefspüler, Abgang Vario, wandbündig
WC au sol, à chasse directe, sortie Vario, dos au mur
Vaso a pavimento, a cacciata, scarico Vario, a filo muro

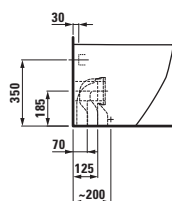
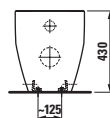
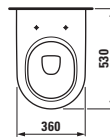

Floorstanding WC combination

Stand-WC-Kombination
Installation de WC au sol
Vaso monoblocco a pavimento

§2295.2

Floorstanding WC, washdown, Vario outlet, back-to-wall

Stand-WC, Tiefspüler, Abgang Vario, wandbündig
WC au sol, à chasse directe, sortie Vario
Vaso a pavimento, a cacciata, scarico Vario, a filo muro

§2866.x

Floorstanding cistern, Dual Flush

Bodenstehender Spülkasten, Dual Flush
Réservoir au sol, Dual Flush
Cassetta di risciacquo a pavimento, Dual Flush

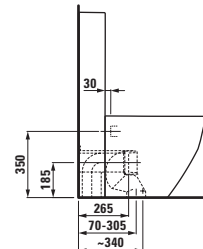
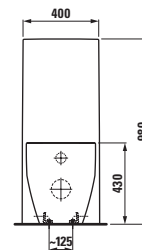



§2866.0 Floorstanding cistern, Dual Flush

Stand-Spülkasten, Dual-Flush
 Réservoir au sol, Dual Flush
 Cassetta di risciacquo a pavimento, Dual Flush

§2866.0

Water connection left or right at the top of the cistern

Wasseranschluss links oder rechts oben am Spülkasten
 Raccordement de l'eau à gauche ou à droite sur le haut du réservoir
 Alimentazione dell'acqua a destra o a sinistra sulla parte superiore della cassetta di risciacquo

§2866.1

Water connection back left at the top of the cistern

Wasseranschluss hinten links oben am Spülkasten
 Raccordement de l'eau à l'arrière à gauche, sur le haut du réservoir
 Alimentazione dell'acqua posteriore sinistra sulla parte superiore della cassetta di risciacquo

§2866.3

Water connection on the left side at the bottom of the cistern

Wasseranschluss auf der linken Seite unten am Spülkasten
 Raccordement de l'eau à gauche sur le bas du réservoir
 Alimentazione dell'acqua a sinistra sulla parte inferiore della cassetta di risciacquo

§2866.4

Water connection on the right side at the bottom of the cistern

Wasseranschluss auf der rechten Seite unten am Spülkasten
 Raccordement de l'eau à droite sur le bas du réservoir
 Alimentazione dell'acqua a destra sulla parte inferiore della cassetta di risciacquo

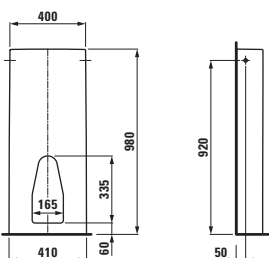

§3295.2.302



Floorstanding bidet, with 1 tap hole in centre, without lateral holes for water inlet

Standbidet, 1 Hahnloch mittig, ohne seitliche Löcher für Wasseranschluss
 Bidet au sol, avec 1 trou pour la robinetterie au milieu, sans trous latéraux pour raccordement de l'eau
 Bidet a pavimento, con 1 foro centrale per la rubinetteria, senza fori laterali per l'alimentazione dell'acqua

§3295.2.308

Floorstanding bidet, with 3 tap holes in centre, without lateral holes for water inlet

Standbidet, mit 3 Hahnlöchern, ohne seitliche Löcher für Wasseranschluss
 Bidet au sol, avec 3 trous pour la robinetterie, sans trous latéraux pour raccordement de l'eau
 Bidet a pavimento, con 3 fori centrali per la rubinetteria, senza fori laterali per l'alimentazione dell'acqua

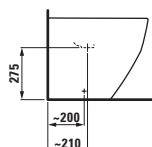
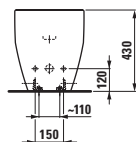
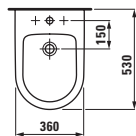

WC seats and covers for WCs

WC-Sitze für WCs
 Sièges et abattants pour WCs
 Sedile per vasi

§2095.6, §2096.5, §2096.6, §2295.2, §2595.2



§9695.0

WC seat and cover LAUFEN pro, removable

WC-Sitz mit Deckel LAUFEN pro, abnehmbar
 Siège et abattant LAUFEN pro, amovibles
 Sedile con coperchio LAUFEN pro, estraibile

§9695.1

WC seat and cover LAUFEN pro, removable, with lowering system

WC-Sitz mit Deckel LAUFEN pro, abnehmbar, mit Absenkautomatik
 Siège et abattant LAUFEN pro, amovibles, avec système d'abaissement
 Sedile con coperchio LAUFEN pro, estraibile, con sistema a caduta rallentata



§9395.5

WC seat and cover Universal

WC-Sitz mit Deckel Universal
 Siège et abattant Universal
 Sedile con coperchio Universal

§9395.6

WC seat and cover Universal, removable, with lowering system

WC-Sitz mit Deckel Universal, abnehmbar, mit Absenkautomatik
 Siège et abattant Universal, amovibles, avec système d'abaissement
 Sedile con coperchio Universal, estraibile, con sistema a caduta rallentata



§2095.0

**Wall-hung WC, washdown
(180 mm distance between
mounting holes)**

*Wand-WC, Tiefspüler (180 mm
Abstand zwischen Befestigungs-
löchern)*

*WC suspendu, à chasse directe
(espacement de boulon de
scellement 180 mm)*

*Vaso sospeso, a cacciata (180 mm
di distanza tra i fori di fissaggio)*

§2095.5

**Wall-hung WC, washdown
(230 mm distance between
mounting holes)**

*Wand-WC, Tiefspüler (230 mm
Abstand zwischen Befestigungs-
löchern)*

*WC suspendu, à chasse directe
(espacement de boulon de
scellement 230 mm)*

*Vaso sospeso, a cacciata (230 mm
di distanza tra i fori di fissaggio)*

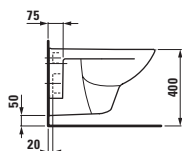
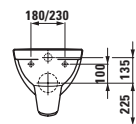
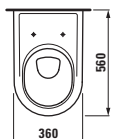

§2095.1

Wall-hung WC, washout

Wand-WC, Flachspüler

WC suspendu, à fond plat

Vaso sospeso, a fondo piatto

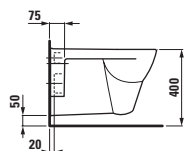
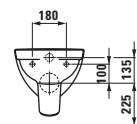
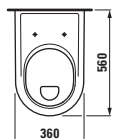

§3095.1.302

**Wall-hung bidet, 1 tap hole in
centre, without lateral holes for
water inlet**

*Wand-Bidet, 1 Hahnloch mittig, ohne
seitliche Löcher für Wasseranschluss*

*Bidet suspendu, avec 1 trou pour la
robinetterie au milieu, sans trous laté-
raux pour le raccordement de l'eau*
*Bidet sospeso, con 1 foro centrale
per la rubinetteria, senza fori laterali
per l'alimentazione dell'acqua*

§3095.1.304

**Wall-hung bidet, with 1 tap hole
in centre, with lateral holes for
water inlet**

*Wand-Bidet, 1 Hahnloch mittig,
mit seitlichen Löchern für Wasser-
anschluss*

*Bidet suspendu, avec 1 trou pour la
robinetterie au milieu, avec trous laté-
raux pour le raccordement de l'eau*
*Bidet sospeso, con 1 foro centrale
per la rubinetteria, con fori laterali
per l'alimentazione dell'acqua*

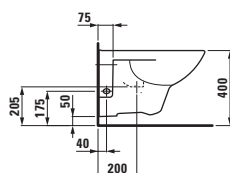
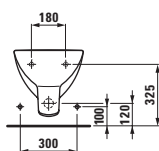
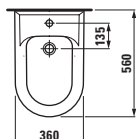

§2095.2

**Wall-hung WC Compact,
washdown, 490 mm projection**

*Wand-WC Compact, Tiefspüler,
Ausladung 490 mm*

*WC suspendu Compact, à chasse
directe, saillie 490 mm*

*Vaso sospeso Compact, a cacciata,
profondità 490 mm*

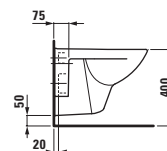
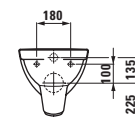
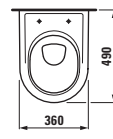



2495.6
Floorstanding WC combination, washdown, horizontal outlet
Stand-WC-Kombination, Tiefspüler, Abgang waagrecht
Installation de WC au sol, à chasse directe, sortie horizontale
Vaso monoblocco a pavimento, a cacciata, scarico a parete

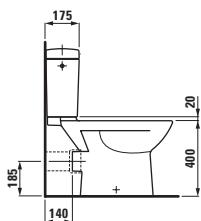
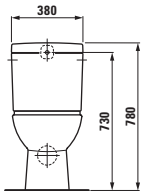
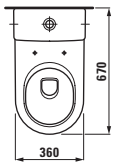

2495.7
Floorstanding WC combination, washdown, vertical outlet
Stand-WC-Kombination, Tiefspüler, Abgang senkrecht
Installation de WC au sol, à chasse directe, sortie verticale
Vaso monoblocco a pavimento, a cacciata, scarico a pavimento

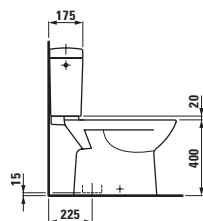
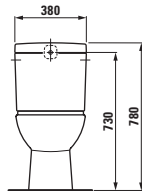
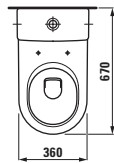

2495.8
Floorstanding WC combination, washdown, outlet Vario
Stand-WC-Kombination, Tiefspüler, Abgang Vario
Installation de WC au sol, à chasse directe, évacuation Vario
Vaso monoblocco a pavimento, a cacciata, scarico Vario



2495.8.231
Floorstanding WC combination, washdown, outlet Vario, with lateral holes for water inlet
Stand-WC-Kombination, Tiefspüler, Abgang Vario, mit seitlichen Löchern für Wasseranschluss
Installation de WC au sol, à chasse directe, évacuation Vario, avec trous latéraux pour le raccordement de l'eau
Vaso monoblocco a pavimento, a cacciata, scarico Vario, con fori laterali per l'alimentazione dell'acqua

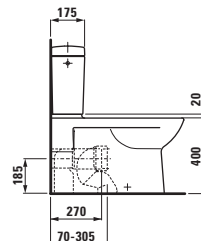
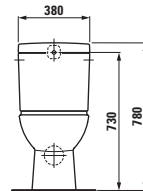
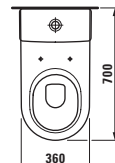

2495.9
Floorstanding WC combination, washout, outlet Vario
Stand-WC-Kombination, Flachspüler, Abgang Vario
Installation de WC au sol, à fond plat, évacuation Vario
Vaso monoblocco a pavimento, a fondo piatto, scarico Vario

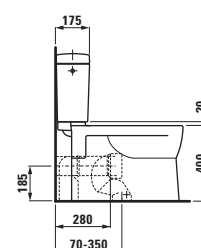
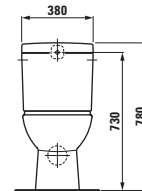
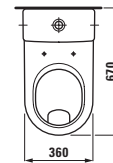



§2495.5

Floorstanding WC combination, washdown, outlet Vario

Stand-WC-Kombination, Tiefspüler, Abgang Vario
Installation de WC au sol, à chasse directe, évacuation Vario
Vaso monoblocco a pavimento, a cacciata, scarico Vario

§2495.5.231

Floorstanding WC combination, washdown, outlet Vario, with lateral holes for water inlet

Stand-WC-Kombination, Tiefspüler, Abgang Vario, mit seitlichen Löchern für Wasseranschluss
Installation de WC au sol, à chasse directe, évacuation Vario, avec trous latéraux pour le raccordement de l'eau
Vaso monoblocco a pavimento, a cacciata, scarico Vario, con fori laterali per l'alimentazione dell'acqua

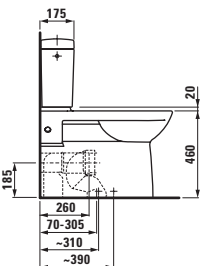
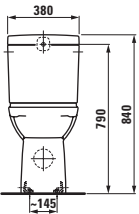
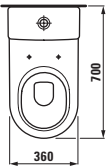

§2295.1

Floorstanding WC, washdown, horizontal/vertical outlet, Vario

Stand-WC, Tiefspüler, Abgang waagrecht/senkrecht, Vario
WC au sol, à chasse directe, sortie horizontale/verticale, Vario
Vaso a pavimento, a cacciata, scarico a parete/a pavimento, Vario

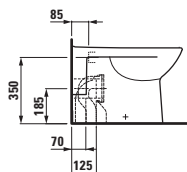
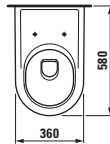

Cistern for WCs

Spülkasten für WCs
Réservoir pour WCs
Cassetta di risciacquo per vasi
§2495.5, §2495.6, §2495.7, §2495.8, §2495.9

§2695.1

Cistern, Dual Flush, water connection at back

Spülkasten, Dual Flush, Wasseranschluss hinten
Réservoir, Dual Flush, raccordement de l'eau à l'arrière
Cassetta di risciacquo, Dual Flush, alimentazione dell'acqua posteriore

§2695.2

Cistern, Dual Flush, water connection on one side (left or right)

Spülkasten, Dual Flush, Wasseranschluss seitlich (links oder rechts)
Réservoir, Dual Flush, raccordement de l'eau latéral (gauche ou droite)
Cassetta di risciacquo, Dual Flush, alimentazione dell'acqua laterale (a sinistra o a destra)

§2695.3

Cistern, Dual Flush, water connection bottom left

Spülkasten, Dual Flush, Wasseranschluss unten links
Réservoir, Dual Flush, raccordement de l'eau inférieure gauche
Cassetta di risciacquo, Dual Flush, alimentazione dell'acqua dal basso a sinistra

§2695.5

Cistern, Dual Flush, water connection bottom right

Spülkasten, Dual Flush, Wasseranschluss unten rechts
Réservoir, Dual Flush, raccordement de l'eau inférieure droite
Cassetta di risciacquo, Dual Flush, alimentazione dell'acqua dal basso a destra



§3295.1.304

Floorstanding bidet, 1 tap hole in centre, without lateral holes for water inlet

Standbidet, 1 Hahnloch mittig, ohne seitliche Löcher für Wasseranschluss
Bidet au sol, 1 trou pour la robinetterie au milieu, sans trous latéraux pour le raccordement d'eau
Bidet a pavimento, 1 foro centrale per la rubinetteria, senza fori laterali per l'alimentazione dell'acqua

§3295.1.308

Floorstanding bidet, with 3 tap holes in centre, without lateral holes for water inlet

Standbidet, mit 3 Hahnlöchern, ohne seitliche Löcher für Wasseranschluss
Bidet au sol, 3 trous pour la robinetterie, sans trous latéraux pour le raccordement d'eau
Bidet a pavimento, 3 fori per la rubinetteria, senza fori laterali per l'alimentazione dell'acqua

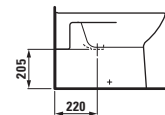
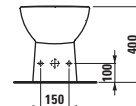
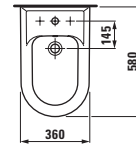



82395.3

One piece WC, including seat and cover, removable, with lowering system

One piece WC, Sitz und Deckel inklusive, abnehmbar, mit Absenksystem

One piece WC, Siège et abattant inclus, amovibles, avec système d'abaissement

One piece WC, Sedile con coperchio compreso, estraibile, con sistema a caduta rallentata

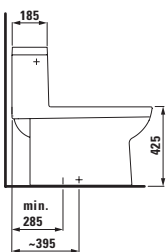
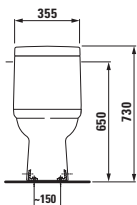
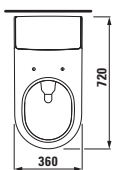

82195.6

Floorstanding WC, washdown, horizontal outlet

Stand-WC, Tiefspüler, Abgang waagrecht

WC au sol, à chasse directe, sortie horizontale

Vaso a pavimento, a cacciata, scarico a parete

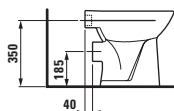
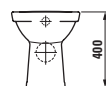
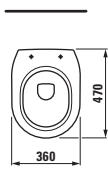

82195.8

Floorstanding WC, washout, horizontal outlet

Stand-WC, Flachspüler, Abgang waagrecht

WC au sol, à fond plat, sortie horizontale

Vaso a pavimento, a fondo piatto, scarico a parete

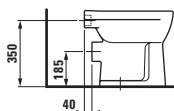
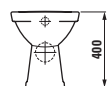
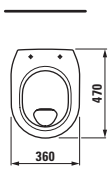

82595.5

Floorstanding WC, washdown, horizontal outlet

Stand-WC, Tiefspüler, Abgang waagrecht

WC au sol, à chasse directe, sortie horizontale

Vaso a pavimento, a cacciata, scarico a parete

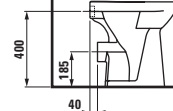
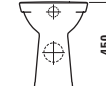



82595.7
**Floorstanding WC, washout,
 vertical outlet**

*Stand-WC, Flachspüler,
 Abgang senkrecht
 WC au sol, à fond plat,
 sortie verticale
 Vaso a pavimento, a fondo piatto,
 scarico a pavimento*

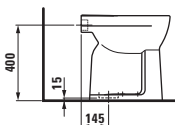
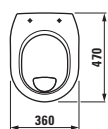

82195.7
**Floorstanding WC, washdown,
 vertical outlet**

*Stand-WC, Tiefspüler,
 Abgang senkrecht
 WC au sol, à chasse directe,
 sortie verticale
 Vaso a pavimento, a cacciata,
 scarico a pavimento*

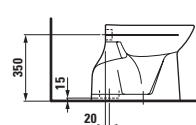
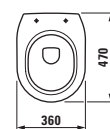

82195.9
**Floorstanding WC, washout,
 vertical outlet**

*Stand-WC, Flachspüler,
 Abgang senkrecht
 WC au sol, à fond plat,
 sortie verticale
 Vaso a pavimento, a fondo piatto,
 scarico a pavimento*

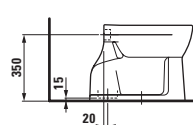
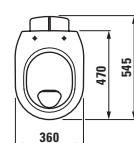

82595.6
**Floorstanding WC, washout,
 horizontal outlet**

*Stand-WC, Flachspüler,
 Abgang waagrecht
 WC au sol, à fond plat,
 sortie horizontale
 Vaso a pavimento, a fondo piatto,
 scarico a parete*

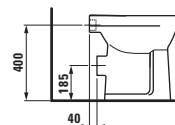
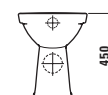

WC seats and covers for WCs

WC-Sitze für WCs

Sièges et abattants pour WCs

Sedile per vasi

82095.0, 82095.1, 82095.2, 82095.3, 82095.4, 82095.5,
82295.1, 82495.5, 82495.6, 82495.7, 82495.8, 82495.9



89195.0

WC seat and cover LAUFEN pro, removable

WC-Sitz mit Deckel LAUFEN pro, abnehmbar

Siège et abattant LAUFEN pro, amovibles

Sedile con coperchio LAUFEN pro, estraibile

89195.1

WC seat and cover LAUFEN pro, removable, with lowering system

WC-Sitz mit Deckel LAUFEN pro, abnehmbar, mit Absenkautomatik

Siège et abattant LAUFEN pro, amovibles, avec système d'abaissement

Sedile con coperchio LAUFEN pro, estraibile, con sistema a caduta rallentata



89395.2

WC seat and cover Universal, removable

WC-Sitz mit Deckel Universal, abnehmbar

Siège et abattant Universal, amovibles

Sedile con coperchio Universal, estraibile

89395.3

WC seat and cover Universal, removable, with lowering system

WC-Sitz mit Deckel Universal, abnehmbar, mit Absenkautomatik

Siège et abattant Universal, amovibles, avec système d'abaissement

Sedile con coperchio Universal, estraibile, con sistema a caduta rallentata



89895.0

WC seat and cover, barrier-free, removable

WC-Sitz mit Deckel, barrierefrei, abnehmbar

Siège et abattant, sans limite, amovibles

Sedile con coperchio, senza barriere, estraibile



89895.1

WC seat, barrier-free, removable

WC-Sitz, barrierefrei, abnehmbar

Siège, sans limite, amovibles

Sedile, senza barriere, estraibile

WC seats and covers for WCs

WC-Sitze für WCs

Sièges et abattants pour WCs

Sedile per vasi

82095.0, 82095.1, 82095.2, 82095.5,
82195.6, 82195.7, 82195.8, 82195.9,
82295.1, 82495.5, 82495.6, 82495.7,
82495.8, 82495.9, 82595.5, 82595.6,
82595.7



89295.0

WC seat LAUFEN pro

WC-Sitz LAUFEN pro

Siège LAUFEN pro

Sedile LAUFEN pro



89295.1

WC seat and cover LAUFEN pro

WC-Sitz mit Deckel LAUFEN pro

Siège et abattant LAUFEN pro

Sedile con coperchio LAUFEN pro

caprino plus



Caprino Plus, siphonic urinal

Caprino Plus, Absauge-Urinal
 Caprino Plus, urinoir à effet siphonique
 Caprino Plus, orinatoio sifonico

84206.1

With concealed water inlet

Zulauf innen
 Entrée d'eau intérieure
 Entrata acqua nascosta

84206.2

With external water inlet

Zulauf aussen
 Entrée d'eau extérieure
 Con entrata acqua esterna

Caprino Plus siphonic urinal, concealed water inlet, with electronic urinal control, vandalproof

Caprino Plus, Absauge-Urinal,
 Zulauf innen, mit elektronischer
 Urinalsteuerung, vandalsicher
 Caprino Plus, urinoir à effet siphonique,
 entrée d'eau intérieure, avec
 commande électronique, protection
 contre le vandalisme
 Caprino Plus, orinatoio sifonico, con
 entrata acqua nascosta, comando
 elettronico, antivandalismo

84206.5

Mains operated

Netzbetrieb
 Alimentation réseau
 Alimentazione a rete

84206.6

Battery operated

Batteriebetrieb
 Alimentation batterie
 Alimentazione a batteria

Options:

.000

.400 with fly

mit Zielfliege
 avec mouche
 con mosca

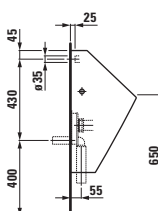
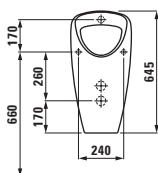
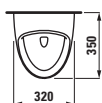

84760.0

Rion, urinal divison

Rion, Urinaltrennwand
 Rion, paroi de séparation pour urinoir
 Rion, aletta divisora fra orinatoio

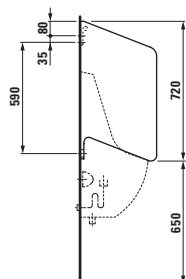
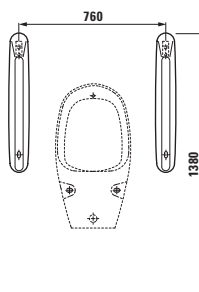
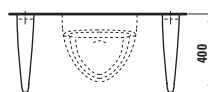



81195.3
Washbasin mixer, barrier-free
 Waschtisch, barrierefrei
 Lavabo, sans limite
 Lavabo, senza barriere



Options:
 .104 .109 .142 .156

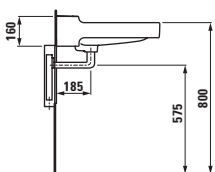
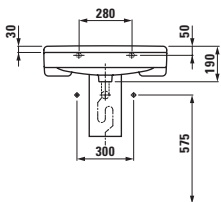
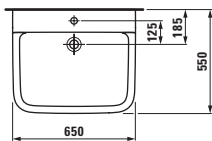

○/●
Washbasin mixer, fixed spout
110 mm, with clinic lever
 Waschtischmischer, Festauslauf
 110 mm, mit clinic Griff
 Mitigeur de lavabo, gaulot fixe
 110 mm, avec levier clinic
 Miscelatore per lavabo, bocca di erogazione fissa 110 mm, con leva clinic

31160.1.004.111.1
With pop-up waste
 Mit Ablaufventil
 Avec vidage
 Con piletta

31160.1.004.110.1
Without pop-up waste
 Ohne Ablaufventil
 Sans vidage
 Senza piletta

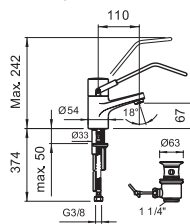

Washbasin mixer, swivel spout
145 mm, with clinic lever
 Waschtischmischer, Schwenkauslauf
 145 mm, mit clinic Griff
 Mitigeur de lavabo, bec orientable,
 saillie 145 mm, avec levier clinic
 Miscelatore per lavabo, bocca di erogazione orientabile, sporgenza 145 mm, con leva clinic

31160.1.004.221.1
With pop-up waste
 Mit Ablaufventil
 Avec vidage
 Con piletta

31160.1.004.220.1
Without pop-up waste
 Ohne Ablaufventil
 Sans vidage
 Senza piletta

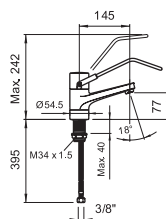

82095.4
Wall-hung WC, washdown
 Wand-WC, Tiefspüler
 WC suspendu, à chasse directe
 Vaso sospeso, a cacciata

89895.0
Seat and cover, barrier-free
 WC-Sitz mit Deckel, barrierefrei
 Siège et abattant, sans limite
 Sedile con coperchio, senza barriere

89895.1
Seat without cover, barrier-free
 WC-Sitz ohne Deckel, barrierefrei
 Siège sans abattant, sans limite
 Sedile senza coperchio, senza barriere

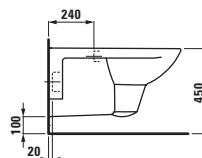
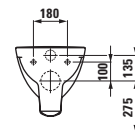
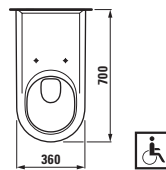

82095.3
Wall-hung WC, washout
 Wand-WC, Flachspüler
 WC suspendu, à fond plat
 Vaso sospeso, a fondo piatto

89895.0
Seat and cover, barrier-free
 WC-Sitz mit Deckel, barrierefrei
 Siège et abattant, sans limite
 Sedile con coperchio, senza barriere

89895.1
Seat without cover, barrier-free
 WC-Sitz ohne Deckel, barrierefrei
 Siège sans abattant, sans limite
 Sedile senza coperchio, senza barriere

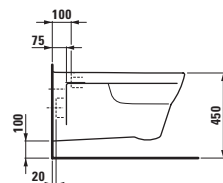
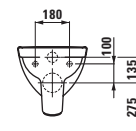
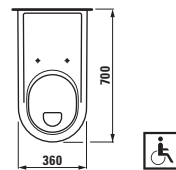

LAUFEN pro, steel bathtubs



22095.0.040

Steel bathtub, 1500x700 mm, 3 mm enamelled steel, with anti-noise-pads

Stahlbadewanne, 1500x700 mm, Stahl-Email 3 mm, mit Anti-Noise-Pads
Baignoire acier, 1500x700 mm, acier émaillé de 3 mm, avec patins antibruit
Vasca in acciaio, 1500x700 mm, acciaio smaltato 3 mm, con cuscinetti antirumore

22095.3.040

As above, with holes for handles

Wie oben, mit Löchern für Griffmontage
Comme ci-dessus, avec trous pour poignée
Come sopra, con fori per maniglia

29618.1

Bathtub handles, chrome plated

Badewannengriffe, verchromt
Poignées pour baignoire, chromées
Maniglie per vasca, cromate

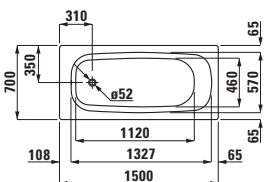

22195.0.040

Steel bathtub, 1500 x 700 mm, 3 mm enamelled steel, with anti-noise-pads

Stahlbadewanne, 1500 x 700 mm, Stahl-Email 3 mm, mit Anti-Noise-Pads
Baignoire acier, 1500 x 700 mm, acier émaillé de 3 mm, avec patins antibruit
Vasca in acciaio, 1500 x 700 mm, acciaio smaltato 3 mm, con cuscinetti antirumore

22195.3.040

As above, with holes for handles

Wie oben, mit Löchern für Griffmontage
Comme ci-dessus, avec trous pour poignée
Come sopra, con fori per maniglia

29618.1

Bathtub handles, chrome plated

Badewannengriffe, verchromt
Poignées pour baignoire, chromées
Maniglie per vasca, cromate

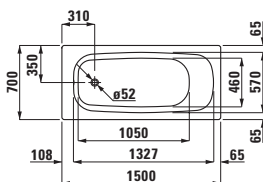

22295.0.040

Steel bathtub, 1500 x 750 mm, 3 mm enamelled steel, with anti-noise-pads

Stahlbadewanne, 1500 x 750 mm, Stahl-Email 3 mm, mit Anti-Noise-Pads
Baignoire acier, 1500 x 750 mm, acier émaillé de 3 mm, avec patins antibruit
Vasca in acciaio, 1500 x 750 mm, acciaio smaltato 3 mm, con cuscinetti antirumore

22295.3.040

As above, with holes for handles

Wie oben, mit Löchern für Griffmontage
Comme ci-dessus, avec trous pour poignée
Come sopra, con fori per maniglia

29618.1

Bathtub handles, chrome plated

Badewannengriffe, verchromt
Poignées pour baignoire, chromées
Maniglie per vasca, cromate

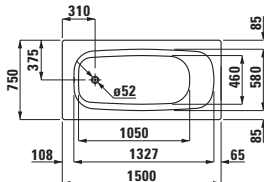

22395.0

Steel bathtub, 1600x700 mm, 3,5 mm enamelled steel

Stahlbadewanne, 1600x700 mm, Stahl-Email 3,5 mm
Baignoire acier, 1600x700 mm, acier émaillé de 3,5 mm
Vasca in acciaio, 1600x700 mm, acciaio smaltato 3,5 mm

22395.0.040

As above, with anti-noise-pads

Wie oben, mit Anti-Noise-Pads
Comme ci-dessus, avec patins antibruit
Come sopra, con cuscinetti anti-rumore

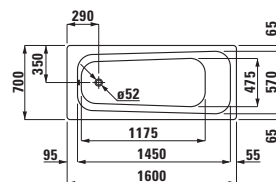

LAUFEN pro, steel bathtubs



22495.0

Steel bathtub, 1700x700 mm, 3,5 mm enamelled steel

Stahlbadewanne, 1700x700 mm, Stahl-Email 3,5 mm
Baignoire acier, 1700x700 mm, acier émaillé de 3,5 mm
Vasca in acciaio, 1700x700 mm, acciaio smaltato 3,5 mm

22495.0.040

As above, with anti-noise-pads

Wie oben, mit Anti-Noise-Pads
Comme ci-dessus, avec patins antibruit
Come sopra, con cuscinetti anti-rumore

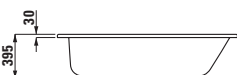
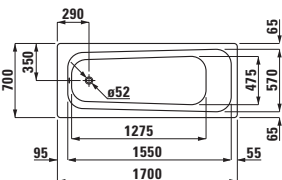

22595.0

Steel bathtub, 1700x750 mm, 3,5 mm enamelled steel

Stahlbadewanne, 1700x750 mm, Stahl-Email 3,5 mm
Baignoire acier, 1700x750 mm, acier émaillé de 3,5 mm
Vasca in acciaio, 1700x750 mm, acciaio smaltato 3,5 mm

22595.0.040

As above, with anti-noise-pads

Wie oben, mit Anti-Noise-Pads
Comme ci-dessus, avec patins antibruit
Come sopra, con cuscinetti anti-rumore

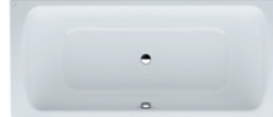
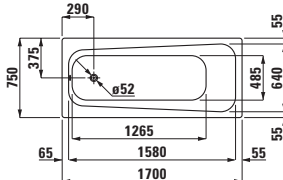

22695.0

Steel bathtub, 1700x750 mm, 3,5 mm enamelled steel

Stahlbadewanne, 1700x750 mm, Stahl-Email 3,5 mm
Baignoire acier, 1700x750 mm, acier émaillé de 3,5 mm
Vasca in acciaio, 1700x750 mm, acciaio smaltato 3,5 mm

22695.0.040

As above, with anti-noise-pads

Wie oben, mit Anti-Noise-Pads
Comme ci-dessus, avec patins antibruit
Come sopra, con cuscinetti anti-rumore

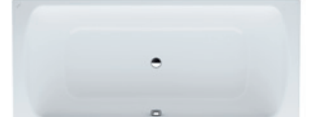
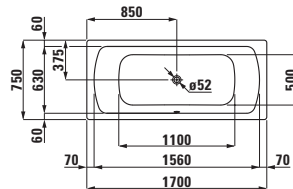

22795.0

Steel bathtub, 1800x800 mm, 3,5 mm enamelled steel

Stahlbadewanne, 1800x800 mm, Stahl-Email 3,5 mm
Baignoire acier, 1800x800 mm, acier émaillé de 3,5 mm
Vasca in acciaio, 1800x800 mm, acciaio smaltato 3,5 mm

22795.0.040

As above, with anti-noise-pads

Wie oben, mit Anti-Noise-Pads
Comme ci-dessus, avec patins antibruit
Come sopra, con cuscinetti anti-rumore

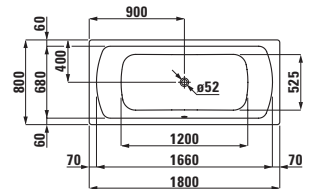

29410.3.016.000.1

Gel pillow, self-adhesive

Gelkissen selbsthaftend
Coussin-gel adhérent
Cuscino in gel autoadesivo

LAUFEN pro, acrylic bathtubs



23395.0
Bathtub, drop-in version, sanitary acrylic, 1600x700 mm
Badewanne, Einbauversion, Sanitäracryl, 1600x700 mm
Baignoire, version encastrée, acrylique sanitaire, 1600x700 mm
Vasca, versione da incasso, in acrilico sanitario, 1600x700 mm

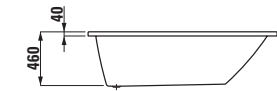
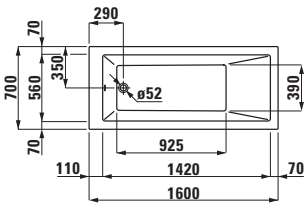

23395.1 **
Bathtub, with frame, sanitary acrylic, 1600x700 mm
Badewanne, mit Fussgestell, Sanitäracryl, 1600x700 mm
Baignoire, avec piétement, acrylique sanitaire, 1600x700 mm
Vasca, con base, in acrilico sanitario, 1600x700 mm

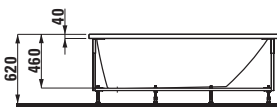
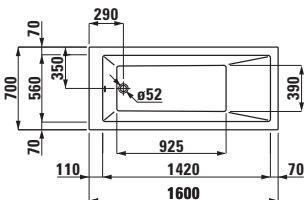

23395.5 **
Bathtub for right-hand corner with L front panel, version left
Badewanne für die rechte Ecke mit L-Schürze links
Baignoire version d'angle droite avec tablier en L, version gauche
Vasca modello angolare dx con pannello a L, lato corto a sinistra

23395.6 **
Bathtub for left-hand corner with L front panel, version right
Badewanne für die linke Ecke mit L-Schürze rechts
Baignoire version d'angle gauche avec tablier en L, version droite
Vasca modello angolare sx con pannello a L, lato corto a destra



23095.0
Bathtub, drop-in version, sanitary acrylic, 1700x700 mm
Badewanne, Einbauversion, Sanitäracryl, 1700x700 mm
Baignoire, version encastrée, acrylique sanitaire, 1700x700 mm
Vasca, versione da incasso, in acrilico sanitario, 1700x700 mm

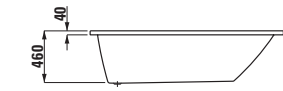
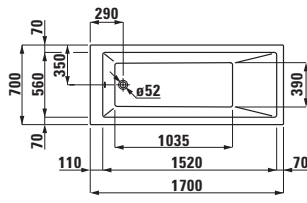

23095.1 **
Bathtub, with frame, sanitary acrylic, 1700x700 mm
Badewanne, mit Fussgestell, Sanitäracryl, 1700x700 mm
Baignoire, avec piétement, acrylique sanitaire, 1700x700 mm
Vasca, con base, in acrilico sanitario, 1700x700 mm

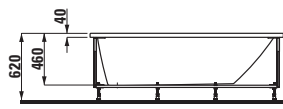
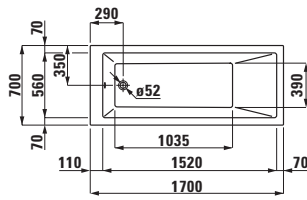

23095.5 **
Bathtub for right-hand corner with L front panel, version left
Badewanne für die rechte Ecke mit L-Schürze links
Baignoire version d'angle droite avec tablier en L, version gauche
Vasca modello angolare dx con pannello a L, lato corto a sinistra

23095.6 **
Bathtub for left-hand corner with L front panel, version right
Badewanne für die linke Ecke mit L-Schürze rechts
Baignoire version d'angle gauche avec tablier en L, version droite
Vasca modello angolare sx con pannello a L, lato corto a destra



23195.0
Bathtub, drop-in version, sanitary acrylic, 1700x750 mm
Badewanne, Einbauversion, Sanitäracryl, 1700x750 mm
Baignoire, version encastrée, acrylique sanitaire, 1700x750 mm
Vasca, versione da incasso, in acrilico sanitario, 1700x750 mm

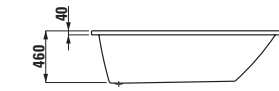
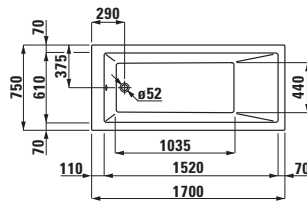

23195.1 **
Bathtub, with frame, sanitary acrylic, 1700x750 mm
Badewanne, mit Fussgestell, Sanitäracryl, 1700x750 mm
Baignoire, avec piétement, acrylique sanitaire, 1700x750 mm
Vasca, con base, in acrilico sanitario, 1700x750 mm

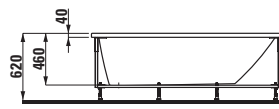
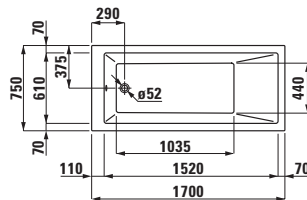

23195.5 **
Bathtub for right-hand corner with L front panel, version left
Badewanne für die rechte Ecke mit L-Schürze links
Baignoire version d'angle droite avec tablier en L, version gauche
Vasca modello angolare dx con pannello a L, lato corto a sinistra

23195.6 **
Bathtub for left-hand corner with L front panel, version right
Badewanne für die linke Ecke mit L-Schürze rechts
Baignoire version d'angle gauche avec tablier en L, version droite
Vasca modello angolare sx con pannello a L, lato corto a destra



23295.0
Bathtub, drop-in version, sanitary acrylic, 1800x800 mm
Badewanne, Einbauversion, Sanitäracryl, 1800x800 mm
Baignoire, version encastrée, acrylique sanitaire, 1800x800 mm
Vasca, versione da incasso, in acrilico sanitario, 1800x800 mm

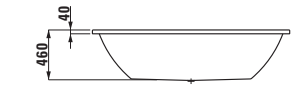
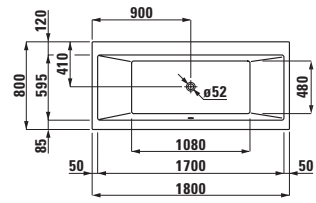

23295.1 **
Bathtub, with frame, sanitary acrylic, 1800x800 mm
Badewanne, mit Fussgestell, Sanitäracryl, 1800x800 mm
Baignoire, avec piétement, acrylique sanitaire, 1800x800 mm
Vasca, con base, in acrilico sanitario, 1800x800 mm

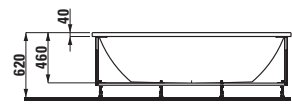
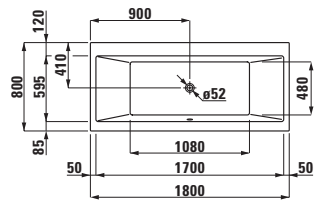

23295.5 **
Bathtub for right-hand corner with L front panel, version left
Badewanne für die rechte Ecke mit L-Schürze links
Baignoire version d'angle droite avec tablier en L, version gauche
Vasca modello angolare dx con pannello a L, lato corto a sinistra

23295.6 **
Bathtub for left-hand corner with L front panel, version right
Badewanne für die linke Ecke mit L-Schürze rechts
Baignoire version d'angle gauche avec tablier en L, version droite
Vasca modello angolare sx con pannello a L, lato corto a destra

LAUFEN pro, acrylic bathtubs



23495.0

Bathtub, drop-in version, sanitary acrylic, 1900x900 mm

Badewanne, Einbauversion, Sanitäracryl, 1900x900 mm
Baignoire, version encastrée, acrylique sanitaire, 1900x900 mm
Vasca, versione da incasso, in acrilico sanitario, 1900x900 mm

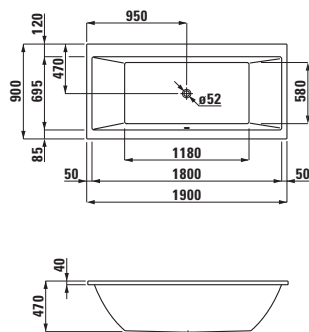

23495.1 **

Bathtub, with frame, sanitary acrylic, 1900x900 mm

Badewanne, mit Fussgestell, Sanitäracryl, 1900x900 mm
Baignoire, avec piétement, acrylique sanitaire, 1900x900 mm
Vasca, con base, in acrilico sanitario, 1900x900 mm

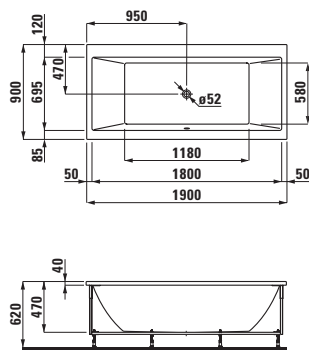

23495.5 **

Bathtub for right-hand corner with L front panel, version left

Badewanne für die rechte Ecke mit L-Schürze links
Baignoire version d'angle droite avec tablier en L, version gauche
Vasca modello angolare dx con pannello a L, lato corto a sinistra

23495.6 **

Bathtub for left-hand corner with L front panel, version right

Badewanne für die linke Ecke mit L-Schürze rechts
Baignoire version d'angle gauche avec tablier en L, version droite
Vasca modello angolare sx con pannello a L, lato corto a destra

Options bathtubs with whirlsystem

Ausführungen Badewannen mit Whirlsystem
Exécutions des baignoires avec balnéo
Versioni delle vasche con sistema idromassaggio

.000 Without whirlsystem

Ohne Whirlsystem
Sans balnéo
Senza sistema idromassaggio

Whirlsystems with sensor

Elektronische Sensorsteuerung
Commande électronique avec détecteur
Sistemi idromassaggio con sensore

| | Air massage/Luftmassage/Aéromassage/ Idromassaggio a getto d'aria | Hydromassage/Wasser massage/ Hydromassage/Idromassaggio aria/acqua | Disinfection/Desinfection/ Désinfection/Igienizzazione | Heating/Heizung/ Chauffage/Riscaldatore | LED light/LED-Licht/ Eclairage LED/Luce a LED | Steam/Dampf/Vapeur/Umidità | Display/Display/Affichage/Display | Music/Musik/Musique/Musica |
|-------------|--|---|---|--|--|----------------------------|-----------------------------------|----------------------------|
| Option .605 | x | | | | | | | |
| Option .615 | | | | | x | | | |
| Option .625 | x | | | | x | | | |
| Option .635 | | x | | | | | | |
| Option .645 | x | x | | | | | | |
| Option .675 | x | x | | | x | | | |
| Option .695 | x | x | x | | x | | | |

Remote control

Fernbedienung
Télécommande
Telecomando

| | Air massage/Luftmassage/Aéromassage/ Idromassaggio a getto d'aria | Hydromassage/Wasser massage/ Hydromassage/Idromassaggio aria/acqua | Disinfection/Desinfection/ Désinfection/Igienizzazione | Heating/Heizung/ Chauffage/Riscaldatore | LED light/LED-Licht/ Eclairage LED/Luce a LED | Steam/Dampf/Vapeur/Umidità | Display/Display/Affichage/Display | Music/Musik/Musique/Musica |
|-------------|--|---|---|--|--|----------------------------|-----------------------------------|----------------------------|
| Option .056 | x | x | x | x | x | | x | x |
| Option .057 | x | x | x | x | x | x | x | x |

Bathtubs of 170 cm length or less are not available with the whirlsystems .056 and .057.

Badewannen mit einer Länge von 170 cm oder weniger, sind nicht mit den Whirlsystemen .056 oder .057 erhältlich.
Les baignoires d'une longueur de 170 cm ou moins ne sont pas disponibles avec les systèmes balnéo .056 ou .057.
Le vasche da bagno di lunghezza fino a 170 cm non sono disponibili con i sistemi di idromassaggio .056 o .057.

Bathtub and panel colours

Farben Badewannen und Schürzen
Couleurs baignoires et tabliers
Colori di vasche e pannelli

 .000 White
Weiss
Blanc
Bianco

 .049 Pergamon*

** Not available for

Nicht erhältlich für
Pas disponible pour
Non disponibile per
23595.0, 23695.0, 23795.0,
23895.0

** Also available with whirlsystem

Auch mit Whirlsystem erhältlich
Egalement disponible avec système balnéo
Disponibile anche con sistema idromassaggio

LAUFEN pro, acrylic bathtubs



23595.0
Bathtub, drop-in version, 3.2 mm sanitary acrylic, 1600x700 mm
Badewanne, Einbauversion, 3,2 mm Sanitäracryl, 1600x700 mm
Baignoire, version encastrée, 3,2 mm acrylique sanitaire, 1600x700 mm
Vasca, versione da incasso, in acrilico sanitario 3,2 mm, 1600x700 mm

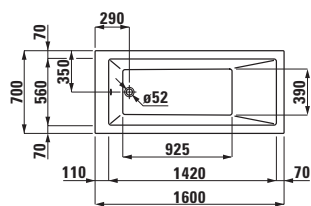

23695.0
Bathtub, drop-in version, 3.2 mm sanitary acrylic, 1700x700 mm
Badewanne, Einbauversion, 3,2 mm Sanitäracryl, 1700x700 mm
Baignoire, version encastrée, acrylique sanitaire 3,2 mm, 1700x700 mm
Vasca, versione da incasso, in acrilico sanitario 3,2 mm, 1700x700 mm

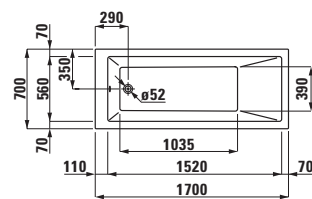

23795.0
Bathtub, drop-in version, 3.2 mm sanitary acrylic, 1700x750 mm
Badewanne, Einbauversion, 3,2 mm Sanitäracryl, 1700x750 mm
Baignoire, version encastrée, acrylique sanitaire 3,2 mm, 1700x750 mm
Vasca, versione da incasso, in acrilico sanitario 3,2 mm, 1700x750 mm

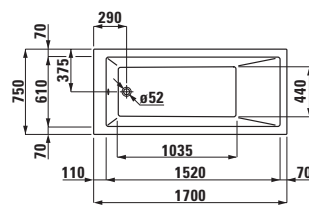

23895.0
Bathtub, drop-in version, 3.2 mm sanitary acrylic, 1800x800 mm
Badewanne, Einbauversion, 3,2 mm Sanitäracryl, 1800x800 mm
Baignoire, version encastrée, acrylique sanitaire 3,2 mm, 1800x800 mm
Vasca, versione da incasso, in acrilico sanitario 3,2 mm, 1800x800 mm

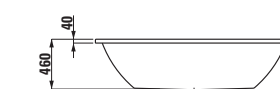
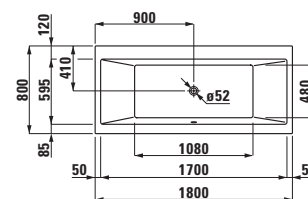

For bathtubs

Für Badewannen

Pour baignoire

Per vasca

23595.0, 23695.0, 23795.0, 23895.0

Side Panels, ABS material

Seitenschürze, ABS Material

Tablier latéral, matériau ABS

Pannello laterale, materiale ABS

29610.6 70x60 cm

29611.6 75x60 cm

29612.6 80x60 cm

29616.0

Installation kit for side panels

Befestigungs-Set für Seitenschürzen

Kit de fixation pour les tabliers latéraux

Set di fissaggio per i pannelli di rivestimento laterali

Front Panels, ABS material

Frontschürze, ABS Material

Tablier avant, matériau ABS

Pannello frontale, materiale ABS

29613.7 160x60 cm

29613.8 170x60 cm

29613.9 180x60 cm

29616.9

Installation kit for front panels

Befestigungs-Set für Frontschürzen

Kit de fixation pour les tabliers avant

Set di fissaggio per i pannelli frontali

29616.8

Standard feet (4 pieces)

Fuss Set (4 Stück)

Kit de pied (4 pièces)

Set di piedini (4 pezzi)



31175.1.004.111.1

**Washbasin mixer, fixed spout,
115 mm spout reach, with pop-up
waste**

Waschtischmischer, Festauslauf,
Ausladung 115 mm, mit Ablaufventil
Mitigeur de lavabo, goulot fixe, saillie
115 mm, avec vidage
Miscelatore per lavabo, bocca di
erogazione fissa, sporgenza 115 mm,
con piletta

31175.1.004.110.1

**Washbasin mixer, fixed spout,
115 mm spout reach, without
pop-up waste**

Waschtischmischer, Festauslauf,
Ausladung 115 mm, ohne
Ablaufventil
Mitigeur de lavabo, goulot fixe, saillie
115 mm, sans vidage
Miscelatore per lavabo, bocca di
erogazione fissa, sporgenza 115 mm,
senza piletta

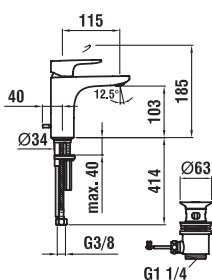

31175.1.004.121.1

**Washbasin mixer, fixed spout,
140 mm spout reach, with pop-up
waste**

Waschtischmischer, Festauslauf,
Ausladung 140 mm, mit Ablaufventil
Mitigeur de lavabo, goulot fixe, saillie
140 mm, avec vidage
Miscelatore per lavabo, bocca di
erogazione fissa, sporgenza 140 mm,
con piletta

31175.1.004.120.1

**Washbasin mixer, fixed spout,
140 mm spout reach, without
pop-up waste**

Waschtischmischer, Festauslauf,
Ausladung 140 mm, ohne
Ablaufventil
Mitigeur de lavabo, goulot fixe, saillie
140 mm, sans vidage
Miscelatore per lavabo, bocca di
erogazione fissa, sporgenza 140 mm,
senza piletta

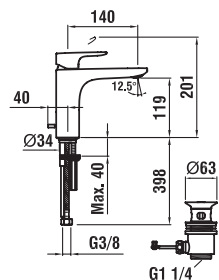

31175.8.004.130.1

**Column basin mixer, fixed spout,
191 mm spout reach, without
pop-up waste**

Standsäulen-Waschtischmischer,
Festauslauf, Ausladung 191 mm,
ohne Ablaufventil
Mitigeur de lavabo à bec recaussé,
goulot fixe, saillie 191 mm, sans
vidage
Miscelatore per lavabo a colonna,
bocca di erogazione fissa, sporgenza
191 mm, senza piletta

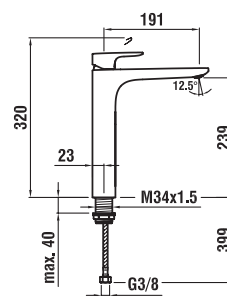

34175.1.004.111.1

**Bidet mixer, fixed spout, 105 mm
spout reach, with pop-up waste**

Bidetmischer, Festauslauf, Ausladung
105 mm, mit Ablaufventil
Mitigeur de bidet, goulot fixe, saillie
105 mm, avec vidage
Miscelatore per bidet, bocca di
erogazione fissa, sporgenza 105 mm
con piletta

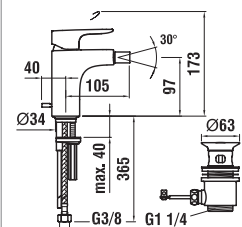



32175.7.004.136.1

Bath mixer, complete with 1500 mm flexible hose and MyCity100 handspray

Bademischer komplett, mit Kunststoffschlauch 1500 mm und MyCity100 Handbrause
 Mitigeur de bain complet, avec flexible synthétique 1500 mm et douchette MyCity100
 Miscelatore da bagno, completo, con tubo sintetico da 1500 mm e doccia MyCity100

32175.7.004.400.1

Bath mixer, with fittings, without accessories

Bademischer mit Verschraubungen, ohne Zubehör
 Mitigeur de bain avec raccords, sans accessoires
 Miscelatore da bagno, con raccordi, senza accessori

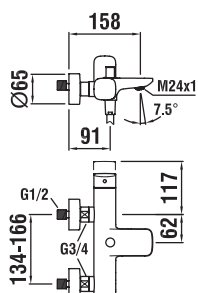

33175.7.004.136.1

Shower mixer, complete with 1500 mm flexible hose and MyCity100 handspray

Duschenmischer komplett, mit Kunststoffschlauch 1500 mm und MyCity100 Handbrause
 Mitigeur de douche complet, avec flexible synthétique 1500 mm et douchette MyCity100
 Miscelatore da doccia, completo, con tubo sintetico da 1500 mm e doccia MyCity100

33175.7.004.400.1

Shower mixer, with fittings, without accessories

Duschenmischer mit Verschraubungen, ohne Zubehör
 Mitigeur de douche avec raccords, sans accessoires
 Miscelatore da doccia, con raccordi, senza accessori

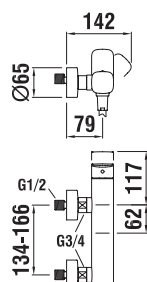

32168.6.004.900.1

Set for concealed bath mixer Simibox, with diverter

Fertigmontage-Set für UP-Bademischer Simibox, mit Umsteller
 Habillage extérieur pour mitigeur de bain encastré Simibox avec inverseur
 Set di montaggio per miscelatore da bagno ad incasso Simibox, con deviatore

32168.6.004.910.1

Set for concealed bath mixer Simibox, with diverter and vacuum breaker

Fertigmontage-Set für UP-Bademischer Simibox, mit Umsteller und Sicherheitseinrichtung
 Habillage extérieur pour mitigeur de bain encastré Simibox avec inverseur et anti-siphonage
 Set di montaggio per miscelatore da bagno ad incasso Simibox, con deviatore e dispositivo di sicurezza

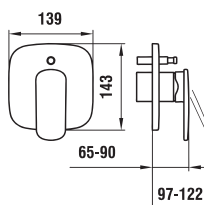

33168.6.004.900.1

Set for concealed shower mixer Simibox

Fertigmontage-Set für UP-Duschenmischer Simibox
 Habillage extérieur pour mitigeur de douche encastré Simibox
 Set di montaggio per miscelatore da doccia ad incasso Simibox

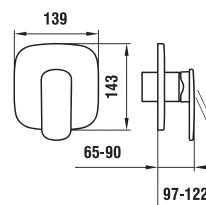



37998.0.000.000.1

Simibox

Concealed system for bath and shower mixer

*Unterputz-Einbaukörper für Bade- und Duschenmischer
Corps encastré pour mitigeur de bain et de douche
Corpo ad incasso per miscelatore da bagno e da doccia*

37998.0.003.000.1

Mounting aid for Simibox

*Montagehilfe für Simibox
Aide de montage pour Simibox
Set di montaggio per Simibox*

37998.0.000.500.1

Flange aid for Simibox

*Flansch für Simibox
Bride pour Simibox
Flangia per Simibox*

37998.0.000.050.1

Extension set L = 25 mm

*Verlängerungsset L = 25 mm
Rallonge L = 25 mm
Prolunga L = 25 mm*

37998.0.000.060.1

Extension set L = 50 mm

*Verlängerungsset L = 50 mm
Rallonge L = 50 mm
Prolunga L = 50 mm*

37998.4.004.050.1

Extension ring for rose, 15 mm

*Verlängerungsring zu Rosette, 15 mm
Bague de rallonge pour rosace, 15 mm
Anello di prolunga per rosetta, 15 mm*

37998.4.004.060.1

Extension ring for rose, 30 mm

*Verlängerungsring zu Rosette, 30 mm
Bague de rallonge pour rosace, 30 mm
Anello di prolunga per rosetta, 30 mm*



31075.1.004.111.1

Washbasin mixer, fixed spout, spout length 115 mm, with pop-up waste

*Waschtischmischer, Festauslauf, Ausladung 115 mm, mit Ablaufventil
Mitigeur de lavabo, goulot fixe, saillie 115 mm, avec vidage
Miscelatore per lavabo, sporgenza 115 mm, con piletta*

31075.1.004.110.1

Washbasin mixer, fixed spout, spout length 115 mm, without pop-up waste

*Waschtischmischer, Festauslauf, Ausladung 115 mm, ohne Ablaufventil
Mitigeur de lavabo, goulot fixe, saillie 115 mm, sans vidage
Miscelatore per lavabo, sporgenza 115 mm, senza piletta*

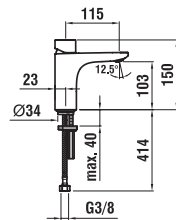

31075.1.004.121.1

Washbasin mixer, fixed spout, spout length 140 mm, with pop-up waste

*Waschtischmischer, Festauslauf, Ausladung 140 mm, mit Ablaufventil
Mitigeur de lavabo, goulot fixe, saillie 140 mm, avec vidage
Miscelatore per lavabo, sporgenza 140 mm, con piletta*

31075.1.004.120.1

Washbasin mixer, fixed spout, spout length 140 mm, without pop-up waste

*Waschtischmischer, Festauslauf, Ausladung 140 mm, ohne Ablaufventil
Mitigeur de lavabo, goulot fixe, saillie 140 mm, sans vidage
Miscelatore per lavabo, sporgenza 140 mm, senza piletta*

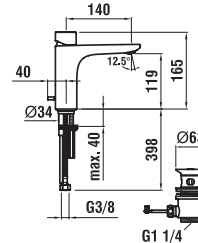

31075.8.004.130.1

Column basin mixer, fixed spout, 191 mm spout reach, without pop-up waste

*Standsäulen-Waschtischmischer, Festauslauf, Ausladung 191 mm, ohne Ablaufventil
Mitigeur de lavabo rehaussé, goulot fixe, saillie 191 mm, sans vidage
Miscelatore per lavabo a colonna, erogazione fissa, sporgenza 191 mm, senza piletta*

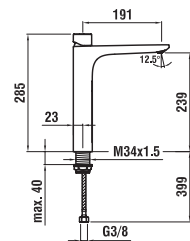

Handle with exchangeable cover. Following colours are available and provided:

Griff mit austauschbarer Farb-Kappe. Folgende Farben sind erhältlich und werden mitgeliefert:

Poignée avec couleurs interchangeable. Les couleurs suivantes sont disponibles et incluses:

Maniglia con colori intercambiabili. Questi colori sono disponibili e compresi:



chrome



nightblack



matt chrome



glacierwhite



pureorange



Swisscross



31195.1.004.111.1

**Washbasin mixer, fixed spout,
110 mm spout reach, with pop-up
waste**

Waschtischmischer, Festauslauf,
Ausladung 110 mm, mit Ablaufventil
Mitigeur de lavabo, goulot fixe, saillie
110 mm, avec vidage
Miscelatore per lavabo, bocca di
erogazione fissa, sporgenza 110 mm,
con piletta

31195.1.004.110.1

**Washbasin mixer, fixed spout,
110 mm spout reach, without
pop-up waste**

Waschtischmischer, Festauslauf,
Ausladung 110 mm, ohne
Ablaufventil
Mitigeur de lavabo, goulot fixe, saillie
110 mm, sans vidage
Miscelatore per lavabo, bocca di
erogazione fissa, sporgenza 110 mm,
senza piletta

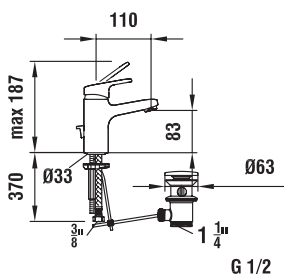

31195.1.004.121.1

**Washbasin mixer, fixed spout,
140 mm spout reach, with pop-up
waste**

Waschtischmischer, Festauslauf,
Ausladung 140 mm, mit Ablaufventil
Mitigeur de lavabo, goulot fixe, saillie
140 mm, avec vidage
Miscelatore per lavabo, bocca di
erogazione fissa, sporgenza 140 mm,
con piletta

31195.1.004.120.1

**Washbasin mixer, fixed spout,
140 mm spout reach, without
pop-up waste**

Waschtischmischer, Festauslauf,
Ausladung 140 mm, ohne
Ablaufventil
Mitigeur de lavabo, goulot fixe, saillie
140 mm, sans vidage
Miscelatore per lavabo, bocca di
erogazione fissa, sporgenza 140 mm,
senza piletta

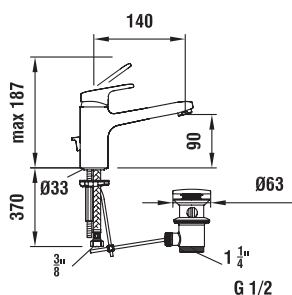

31195.1.504.130.1

**Column basin mixer, fixed spout,
190 mm spout reach, without
pop-up waste**

Standsäulen-Waschtischmischer,
Festauslauf, Ausladung 190 mm,
ohne Ablaufventil
Mitigeur de lavabo rehaussé, goulot
fixe, saillie 191 mm, sans vidage
Miscelatore per lavabo a colonna,
erogazione fissa, sporgenza 190 mm,
senza piletta

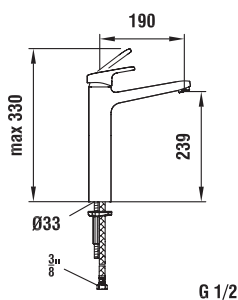

31195.7.004.220.1

**Wall-mounted washbasin mixer,
swivel spout, spout length
175 mm**

Wandmischer, Schwenkauslauf,
Ausladung 175 mm
Mitigeur de lavabo mural, goulot
orientable, saillie 175 mm
Miscelatore per lavabo a muro,
bocca di erogazione orientabile,
sporgenza 175 mm

31195.7.004.230.1

**Wall-mounted washbasin mixer,
swivel spout, spout length
225 mm**

Wandmischer, Schwenkauslauf,
Ausladung 225 mm
Mitigeur de lavabo mural, goulot
orientable, saillie 225 mm
Miscelatore per lavabo a muro,
bocca di erogazione orientabile,
sporgenza 225 mm

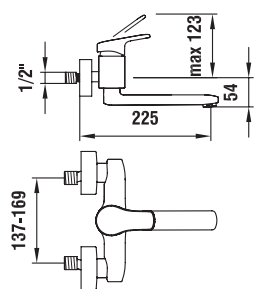
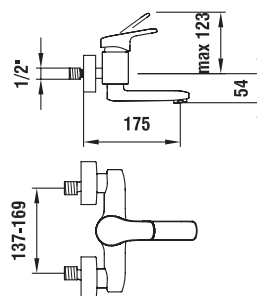



34195.1.004.111.1

Bidet mixer, fixed spout, 96 mm spout reach, with pop-up waste

*Bidetmischer, Festauslauf, Ausladung 96 mm, mit Ablaufventil
Mitigreur de bidet, goulot fixe, saillie 96 mm, avec vidage
Miscelatore per bidet, bocca di erogazione fissa, sporgenza 96 mm con piletta*

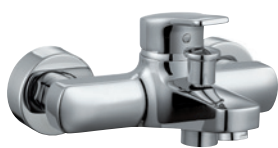
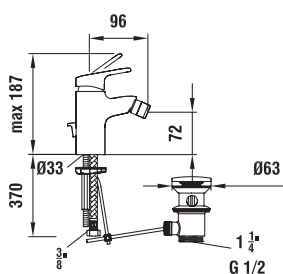

32195.7.004.131.1

Bath single-lever mixer complete, with flexible hose 1500 mm and Aquajet handspray

*Bademischer komplett mit Kunststoffschlauch 1500 mm und Handbrause Aquajet
Mitigreur de bain complet, avec flexible synthétique 1500 mm et douche à main Aquajet
Miscelatore da bagno completo, con tubo sintetico 1500 mm e doccetta Aquajet*

32195.7.004.400.1

Bath single-lever mixer, with fittings, without accessories

*Bademischer, mit Verschraubungen, ohne Zubehör
Mitigreur de bain, avec raccords, sans accessoires
Miscelatore da bagno, con raccordi, senza accessori*

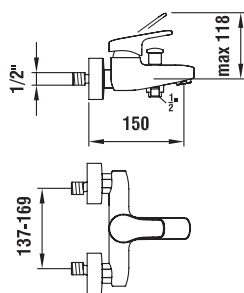

33195.7.004.131.1

Shower single-lever mixer complete, with flexible hose 1500 mm and Aquajet handspray

*Duschenmischer komplett mit Kunststoffschlauch 1500 mm und Handbrause Aquajet
Mitigreur de douche complet, avec flexible synthétique 1500 mm et douche à main Aquajet
Miscelatore per doccia completo, con tubo sintetico 1500 mm e doccetta Aquajet*

33195.7.004.400.1

Shower single-lever mixer, with fittings, without accessories

*Duschenmischer, mit Verschraubungen, ohne Zubehör
Mitigreur de douche, avec raccords, sans accessoires
Miscelatore da doccia, con raccordi, senza accessori*

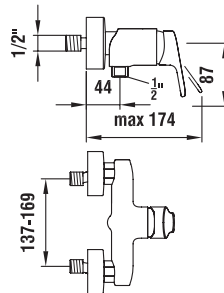

32195.2.004.137.1

Bath/shower deck mounted mixer, gauge 180 mm, complete, with flexible hose 1500 mm and Aquajet handspray

*Wannenrand-Bademischer, Anschlussdistanz 180 mm, komplett mit Kunststoffschlauch 1500 mm und Handbrause Aquajet
Mitigreur de bain/douche sur gorge, écartement 180 mm, complet, avec flexible synthétique 1500 mm et douche à main Aquajet
Miscelatore da bagno su bordo, distanza 180 mm, completo, con tubo sintetico 1500 mm e doccetta Aquajet*

32195.2.004.400.1

Bath/shower deck mounted mixer, gauge 180 mm, with fittings, without accessories

*Wannenrand-Bademischer, Anschlussdistanz 180 mm, mit Verschraubungen, ohne Zubehör
Mitigreur de bain/douche sur gorge, écartement 180 mm, avec raccords, sans accessoires
Miscelatore da bagno su bordo, distanza 180 mm, con raccordi, senza accessori*

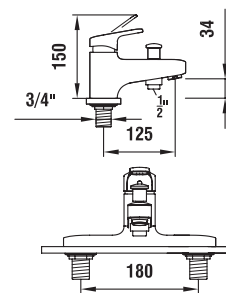



32195.8.004.400.1

Bath deck mounted mixer, gauge 180 mm

Wannenrand-Bademischer, Anschlussdistanz 180 mm
Mitigeur de bain sur gorge, écartement 180 mm
Miscelatore da bagno su bordo, distanza 180 mm

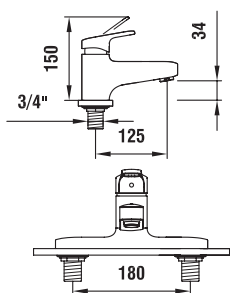

32395.7.004.400.1

Thermostatic bath/shower mixer, with fittings, without accessories

Thermostat Bad/Duschenmischer, mit Verschraubungen, ohne Zubehör
Mitigeur de bain/douche, thermostatique, avec raccords, sans accessoires
Miscelatore termostatico da bagno, con raccordi, senza accessori

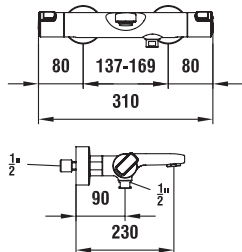

33395.7.004.400.1

Thermostatic shower mixer, with fittings, without accessories

Thermostat Duschenmischer, mit Verschraubungen, ohne Zubehör
Mitigeur de douche thermostatique, avec raccords, sans accessoires
Miscelatore termostatico per doccia, con raccordi, senza accessori

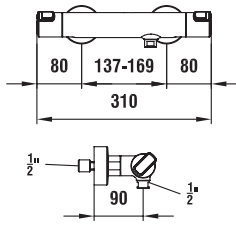

33395.7.004.536.1

citypro Showerstation, including thermostatic shower mixer, rain shower head Ø 206 mm, flexible hose 1500 mm and handspray AquaJet

citypro Showerstation, komplett mit thermostatischem Duschenmischer, runde Regenbrause Ø 206 mm, Kunststoffschlauch 1500 mm und Handbrause AquaJet
citypro Showerstation, complet avec mitigeur de douche thermostatique, pomme de douche pluie Ø 206 mm, flexible synthétique 1500 mm et douchette AquaJet
citypro Showerstation, completo con miscelatore termostatico, per doccia, soffione a pioggia Ø 206 mm, tubo sintetico 1500 mm e doccetta AquaJet

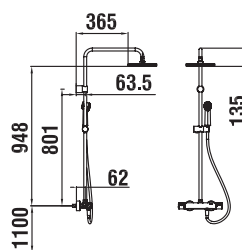



37195.0.004.060.1

Wall spout, fixed spout 185 mm

Wanneneinlauf 185 mm

Goulot mural 185 mm

Bocca di erogazione vasca a muro 185 mm

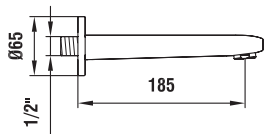

31195.8.004.110.1

Cold water tap, spout length 110 mm, without pop-up waste

Kaltwasserventil, Ausladung 110 mm, ohne Ablaufventil

Robinet à eau froide, saillie 110 mm, sans vidage

Rubinetto ad acqua fredda, sporgenza 110 mm, senza piletta

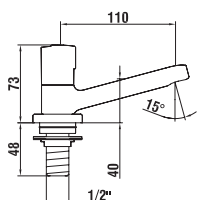

32195.6.004.000.1

Set for concealed bath mixer Simibox, with diverter

Fertigmontage-Set für UP-Bademischer Simibox, mit Umsteller
Habillage extérieur pour mitigeur de bain encastré Simibox avec inverseur
Set di montaggio per miscelatore da bagno ad incasso Simibox, con deviatore

32195.6.004.010.1

Set for concealed bath mixer Simibox, with diverter and vacuum breaker

Fertigmontage-Set für UP-Bademischer Simibox, mit Umsteller und Sicherheitseinrichtung
Habillage extérieur pour mitigeur de bain encastré Simibox avec inverseur et anti-siphonage
Set di montaggio per miscelatore da bagno ad incasso Simibox, con deviatore e dispositivo di sicurezza



33195.6.004.000.1

Set for concealed shower mixer Simibox

Fertigmontage-Set für UP-Duschenmischer Simibox
Habillage extérieur pour mitigeur de douche encastré Simibox
Set di montaggio per miscelatore da doccia ad incasso Simibox



37898.0.000.000.1

Simibox Concealed system for bath and shower mixer

Unterputz-Einbaukörper für Bade- und Duschenmischer
Corps encastré pour mitigeur de bain et de douche
Corpo ad incasso per miscelatore da bagno e da doccia

37998.0.003.000.1

Mounting aid for Simibox

Montagehilfe für Simibox
Aide de montage pour Simibox
Set di montaggio per Simibox

37998.0.000.500.1

Flange aid for Simibox

Flansch für Simibox
Bride pour Simibox
Flangia per Simibox

37998.0.000.050.1

Extension set L = 25 mm

Verlängerungsset L = 25 mm
Rallonge L = 25 mm
Prolunga L = 25 mm

37998.0.000.060.1

Extension set L = 50 mm

Verlängerungsset L = 50 mm
Rallonge L = 50 mm
Prolunga L = 50 mm

37998.4.004.050.1

Extension ring for rose, 15 mm

Verlängerungsring zu Rosette, 15 mm
Bague de rallonge pour rosace, 15 mm
Anello di prolunga per rosetta, 15 mm

37998.4.004.060.1

Extension ring for rose, 30 mm

Verlängerungsring zu Rosette, 30 mm
Bague de rallonge pour rosace, 30 mm
Anello di prolunga per rosetta, 30 mm

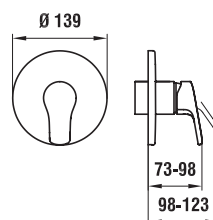
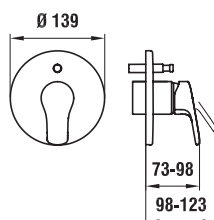



Ceramic colours

Keramikfarben

Couleurs céramique

Colori della ceramica

| | |
|--|---|
|  | .000 White Weiss Blanc Bianco |
|  | .400 White LCC Weiss LCC Blanc LCC Bianco LCC (Laufen Clean Coat) |
|  | .018 Bahamabeige/ Beige Bahama |
|  | .037 Manhattan |
|  | .046 Whisperblue |
|  | .049 Pergamon |
|  | .050 Ägäis/Egée |
|  | .757 White matt Weiss matt Blanc mat Bianco opaco |

Types of washbasins

Ausführungen Waschtische

Exécutions lavabos

Modelli lavabi

- .104 1 tap hole**
- 1 Hahnloch
1 trou pour la robinetterie
1 foro per la rubinetteria
- .105 1 tap hole left**
- 1 Hahnloch links
1 trou pour la robinetterie à gauche
1 foro per la rubinetteria a sinistra
- .106 1 tap hole right**
- 1 Hahnloch rechts
1 trou pour la robinetterie à droite
1 foro per la rubinetteria a destra
- .108 3 tap holes**
- 3 Hahnlöcher
3 trous pour la robinetterie
3 fori per la rubinetteria
- .109 Without tap hole**
- Ohne Hahnloch
Non percé
Senza foro per la rubinetteria
- .112 Without tap hole, without overflow**
- Ohne Hahnloch, ohne Überlauf
Non percé, sans trop-plein
Senza foro per la rubinetteria, senza troppopieno
- .142 No tap hole, no overflow, no open drain**
- Ohne Hahnloch, ohne Überlauf, ohne Öffnung im Ablaufventil
Non percé, sans trop-plein apparent, sans ouverture dans la valve d'écoulement
Senza foro per la rubinetteria, senza troppopieno, senza apertura nella valvola di scarico
- .155 Without tap hole, glazed inside and outside**
- Ohne Hahnloch, innen und aussen glasiert
Non percé, coupé sur 1 côté, émaillé sur l'intérieur et l'extérieur
Senza foro per la rubinetteria, interno ed esterno smaltato
- .156 With tap hole, no overflow, no open drain**
- Mit Hahnloch, ohne Überlauf, ohne Öffnung im Ablaufventil
Avec trou pour la robinetterie, sans trop-plein apparent, sans ouverture dans la valve d'écoulement
Con foro per la rubinetteria, senza troppopieno, senza apertura nella valvola di scarico



It is possible that not all products, sizes or colours are available in every country. The price list of your LAUFEN/ROCA subsidiary is the most accurate reference point for product availability. Delivery periods may also differ.

Unter Umständen sind nicht alle Produkte, Grössen oder Farben in jedem Land verfügbar. Bitte nutzen Sie die Preisliste der jeweiligen LAUFEN/ROCA Niederlassung als Referenz für das verfügbare Produktsortiment. Auch die jeweiligen Lieferzeiten können von Land zu Land abweichen.

Il se peut que les produits ne soient pas tous disponibles dans chaque pays dans toutes les dimensions et coloris. La liste de prix de votre filiale LAUFEN/ROCA est la référence la plus sûre en ce qui concerne la disponibilité des produits. Les délais de livraisons peuvent également varier d'un pays à l'autre.

È possibile che non tutti i prodotti, le misure e i colori siano ugualmente disponibili in ogni Paese. Si prega di utilizzare il listino prezzi della vostra filiale LAUFEN/ROCA come riferimento per la gamma di prodotti disponibili. Anche i tempi di consegna possono variare da un Paese all'altro.

The illustrated colours only approximately correspond to the actual shades. The bathroom layouts shown here are purely decorative and do not reflect all the technical requirements. The decorative parts used are not included in our commercial offer. We reserve the right to make technical changes without prior notice. Registered design.

Die Farbbildungen entsprechen nur in etwa den tatsächlichen Farbtönen. Die hier gezeigten Badmilieus sind rein dekorativ und berücksichtigen nicht alle technischen Anforderungen. Unser Angebot beinhaltet nicht die verwendete Dekoration. Technische Änderungen sind vorbehalten. Design geschützt.

Les photos couleur ne correspondent que partiellement aux teintes effectives. Les ambiances reproduites ici sont simplement décoratives, les exigences techniques d'installation n'ont pas toujours été prises en compte. La décoration utilisée ne fait pas partie de notre offre commerciale. Sous réserve de modifications techniques. Modèle déposé.

I colori qui illustrati non corrispondono esattamente alle tonalità effettive. Gli ambienti qui riprodotti sono puramente decorativi e non tengono conto di tutte le specifiche tecniche. Gli articoli d'arredo usati non fanno parte della nostra offerta commerciale. Con riserva di apportare modifiche tecniche. Modello depositato.

Products with the Q-Plus certification comply with the European standard, as well as with the proven higher Swiss standard laid down by suissetec/VSA. LAUFEN ceramic products comply with this Swiss quality standard and are recommended accordingly.

Produkte mit der Q-Plus-Zertifizierung entsprechen einerseits der Europeanorm und andererseits zusätzlich dem bewährten, höheren Schweizer Standard, welcher durch die suissetec/VSA festgelegt wurde. LAUFEN Keramikprodukte entsprechen diesen schweizerischen Qualitätsmassstäben und haben die entsprechende Zulassungsempfehlung.

Les produits avec certification Q-Plus correspondent à la norme européenne et satisfont en plus aux standards suisses définis par la suissetec/VSA, encore plus élevés et qui ont largement fait leurs preuves. Les produits en céramique signés LAUFEN sont conformes à ces critères de qualité suisses et bénéficient donc des recommandations d'homologation correspondantes.

I prodotti con la certificazione Q-Plus sono conformi sia alla normativa europea sia allo standard svizzero, che prevede requisiti ancora più rigorosi, stabiliti dalla suissetec/VSA. I prodotti in ceramica LAUFEN rispettano questi criteri qualitativi svizzeri e dispongono della relativa certificazione di qualità.

Printed on certified paper from sustainably managed forests.

Gedruckt auf zertifiziertem Papier. Aus nachhaltig bewirtschafteten Wäldern.

Imprimé sur du papier certifié. Issu de forêts exploitées de façon durable.

Stampato su carta certificata. Proveniente da boschi a gestione sostenibile.

Headquarters:

LAUFEN Bathrooms AG
Wahlenstrasse 46
CH-4242 Laufen
Tel. +41 61 765 71 11
Fax +41 61 761 36 60
feedback@laufen.ch
www.laufen.com

Export:

LAUFEN Bathrooms AG
Wahlenstrasse 46
CH-4242 Laufen
Tel. +41 61 765 76 09
Fax +41 61 765 77 77
export@laufen.ch
www.laufen.com/export

Asia:

Roca Sanitaryware Ltd.
Room 2303, 23/F
148 Electric Road
North Point, Hong Kong
Tel. +852 250 624 38
Fax +852 250 624 92
laufenasia@hongkong.laufen.ch
www.laufen.com/export

Australia, New Zealand and Oceania:

ROCA Bathroom Products
Australia P/L
Suite 304, Level 3
191 Clarence Street
Sydney, 2000
NSW, Australia
Tel. +61 (2) 9290 2331
Fax +61 (2) 9290 2786
josep.royo@roca.net
www.laufen.com.au

Austria:

LAUFEN Austria AG
Mariazeller Strasse 100
A-3150 Wilhelmsburg
Tel. +43 2746 6060
Fax +43 2746 6060 380
office.wi@at.laufen.com
www.laufen.co.at

Bosnia Herzegovina, Croatia, Kosovo, Macedonia, Montenegro, Serbia, Slovenia:

INKER d.d.
Industrijska 1
10290 Zaprešić
Tel. +385 1 3310 364
Fax +385 1 3310 275
info@inker.hr
www.laufen.com

Benelux:

LAUFEN Benelux B.V.
Meidoornkade 2A
NL-3992 AE Houten
Tel. +31 (0)33 450 20 90
Fax +31 (0)33 450 20 91
info.benelux@laufen.ch
www.laufen.nl
www.laufen.be

Brazil:

Roca Sanitários Brasil Ltda.
Av. 14 de Dezembro,
2.800 - V. Mafalda
CEP: 13206-105
Jundiaí - SP - Brasil
Tel. Adm. Vendas: +55 11 3378-4827
Assistência Técnica: 0800 70 11 510
Fax +55 11 4587-2324
info.br@laufen.com
www.laufen.com/br

Bulgaria:

Roca Bulgaria AD
5, Pirotska Str.
1301 Sofia, Bulgaria
Tel. +359 29 30 59 10
Fax +359 02 93 59 18
office.sofia@bg.roca.net
www.roca.com

China:

Roca Sanitary Trading
(Shanghai) co. Ltd
Room 503-505, City Gateway
No. 396 North Caoxi Road
Shanghai 200030, China
Tel. +86 21 3368 8822
Fax +86 21 3368 8299
laufen_cn@roca.net.cn
www.cn.laufen.com

Czech Republic:

LAUFEN CZ s.r.o.
V Tůňich 3/1637
120 00 Praha 2
Tel. +420 296 337 711
Fax +420 296 337 713
galerie@cz.laufen.com
www.laufen.cz

Estonia, Latvia:

LAUFEN CZ s.r.o.
Pae 25-8
Tallinn, 11414
Estonia
Tel./Fax +372 6 215 569
office.tallinn@ee.laufen.com
www.laufen.com

France:

LAUFEN France
19-21, rue de Bretagne
Z.I. des Béthunes
F-95310 St-Ouen-L'Aumône
Tel. +33 1 34 40 39 31
Fax +33 1 30 37 02 65
commercial@laufen-france.com
www.laufen.com/fr

Germany:

Roca GmbH
Vertrieb LAUFEN
Feincheswiese 17
56424 Staudt
Tel. +49 26 02 / 94 93 33
Fax +49 26 02 / 94 93 355
info.staudt@de.laufen.com
www.de.laufen.com

Hungary:

LAUFEN CZ s.r.o.
Hungarian Trade Agency
Pasaréti u. 83
H-1026 Budapest
Tel. +36 1 274 05 35
Fax +36 1 391 04 58
office.budapest@hu.laufen.com
www.laufen.com

India:

Roca Bathroom Products Pvt. Ltd.
3rd Floor, Tower B,
DLF Building No. 10, Phase – II
DLF Cyber City,
Gurgaon – 122002, Haryana
India
Tel. +91 124 4278347-49
Fax +91 124 4278350
info.laufen@in.roca.com
www.laufen.com/export

Italy:

LAUFEN Italia s.r.l.
via G. Matteotti, 157
I-20082 Binasco (MI)
Tel. +39 02 900 16 01
Fax +39 02 905 22 19
info@laufen.it
www.laufen.it

Lithuania:

LAUFEN CZ s.r.o.
Užupio g. 30
Vilnius, 01203
Lietuva
Tel. +370 5 215 30 76
Fax +370 5 215 30 86
office.vilnius@lt.laufen.com
www.laufen.lt

Morocco:

Roca Maroc, S.A.
route de Marrakech, km 2,5
BP 571, 26000 Settat
Tel. +212 5 23 40 59 41
Fax +212 5 23 40 59 42
www.roca.com

Nordic countries:

Laufen Nordic ApS
Torvet 15, Baghuset
DK-4600 Koge
Tel. +45 56 287 287
Fax +45 56 287 237
info@dk.laufen.com
www.laufen.dk
www.laufen.fi
www.laufen.no
www.laufen.se

North America:

Laufen Bathrooms North America
11190 NW 25th Street
Miami, FL 33172
USA
Toll free phone +1 (866) 696-2493
+1 (305) 357-6130
Toll free fax +1 (866) 264-7622
usa@laufen.com
canada@laufen.com
www.laufen.com/usa
www.laufen.com/ca
www.laufen.com.mx

Poland:

Roca Polska Sp. z o.o.
ul. Wyczółkowskiego 20
44-109 Gliwice
Tel. +48 32 339 41 00
Fax +48 32 339 41 01
biuro@roca.pl
www.laufen.pl

Portugal:

Roca, S.A., Portugal
Apartado 575, Ponte da Madalena
2416-905 - Leiria, Portugal
Tel. +351 244 720 000
Fax +351 244 722 373
marketing.le@pt.roca.net
www.laufen.pt

Romania:

Roca Obiecte Sanitare S.R.L.
Blvd. Preciziei nr. 1, Sector 6
062202 - Bucharest - Romania
Tel. +4031 822 2310
Fax +4021 318 1418
www.laufen.com

Russia:

Roca Rus
Promyshlennaya Str. 7, Tosno
Leningrad region, 187000, Russia
Tel. +7 812 347 94 49
Fax +7 812 347 94 50
marketing@ru.roca.net
www.laufen.ru

Roca Rus

2nd Hutorskaya, 38A, building 14
Moscow, 127287, Russia
Tel. +7 495 989 65 91
Fax +7 495 959 65 93
marketing@ru.roca.net
www.laufen.ru

Slovakia:

LAUFEN SK s.r.o.
Štefanovičova 12
811 04 Bratislava
Tel. +421 2 526 210 24
Fax +421 2 526 210 25
office.bratislava@sk.laufen.com
www.laufen.sk

Spain:

LAUFEN Bathrooms S.A.
Paseo de la Castellana 98
28046 Madrid
España
Tel./Fax 900 103 258 – free call
info@es.laufen.com
www.laufen.com/es

Switzerland:

Keramik Laufen AG
Wahlenstrasse 46
CH-4242 Laufen
Tel. +41 61 765 71 11
Fax +41 61 761 29 22
forum@laufen.ch
www.laufen.ch

Ukraine:

LAUFEN CZ s.r.o. Ukraine
Kiev 04128
19, Ak. Tupoleva str., office „Laufen“
Tel. +380 44 499 0620
Fax +380 44 499 0621
office.kiev@ua.laufen.com
www.laufen.net.ua

United Kingdom and Ireland:

LAUFEN Ltd.
c/o Roca Ltd.
Samson Road
Hermitage Industrial Estate
Coalville
Leicestershire
LE67 3FP
Tel. +44 (0)1530 510007
Fax +44 (0)1530 838949
info@uk.laufen.com
www.laufen.co.uk

